

2022
PRODUCT CATALOG



PROFESSIONAL INDUSTRIAL EQUIPMENT



At the Summit of the Quarter-Century Sector...

www.metinakinmetal.com.tr



Quarter-Century At The Top Of The Industry



Web www.metinakinmetal.com.tr

☎ 444 25 46

YouTube [akinmetaltv](https://www.youtube.com/akinmetaltv)

Twitter [akinmetal](https://twitter.com/akinmetal)

Facebook [akinmetal](https://www.facebook.com/akinmetal)

Instagram [metinakinmetal](https://www.instagram.com/metinakinmetal)



METİN AKIN METAL SAN. ve TİC. LTD. ŞTİ.

As the owner of the company, Akın Metal San was founded in 1996 with the experience he had gained by actually working abroad for 15 years on roadside assistance and maintenance repair tools, insulation and shelving systems. and tic. Ltd. Şti. it started its activities as Metin AKIN metal after 2008 San.ve Tic. Ltd. Şti. It is active in the field of in-vehicle equipment, Workbenches, Material cabinets, Tool cars and Special productions.

it serves you with its 10.000 m2 working area, professional staff and 800 m2 sales store. Fields of activity roadside assistance maintenance and repair vehicles, automobile services, factories, shipyards, airports, universities and many other sectors are addressed. The company, which has sufficient experience in its field, produces all over Turkey and abroad with its owner and professional staff. We are proud to be a company that can stand behind standard and custom manufacturing projects, a wide product range, plenty of options, quality in production, unlimited design, color options and products.





YOUR SOLUTION PARTNER!





Profile Work Benches	04-29
Modular Work Benches	30-37
Monoblock Work Benches	38-41
Disassembled Work Benches	42-45
Electrician and Electronics Work Benches	46-47
Tool Cars	48-61
Drawer Caissons	62-63
Material Cabinets	64-75
Mors Holder Cabinets, Trolleys and Tables	76-81
Computer and Operator Cabinets	82-83
Lockers	84-85
Tool Stand & Cabinets	86-87
Box Stands and Cabinets	88-89
Handling Equipment	90-91
Shelf Systems	92-95
Special Products	96-97
Defense Industry Equipment	98-99
In-Vehicle Equipment	100-111
Hangers	112-113
Telescopic Rail Systems	114-123
Sectoral Solutions	124-136

Drawer Dimensions



- ▶ Drawer width: 652 mm
- ▶ Drawer width: 534 mm



- ▶ Drawer width: 1148 mm
- ▶ Drawer width: 948 mm
- ▶ Drawer width: 856 mm
- ▶ Drawer width: 768 mm

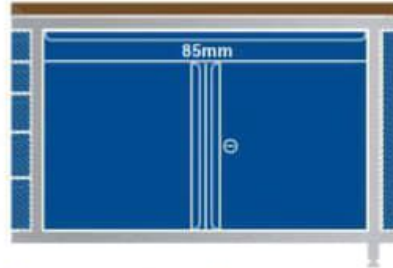

- ▶ Drawer width: 932 mm
- ▶ Drawer width: 772 mm



- ▶ Drawer width: 665 mm

Telescopic Rail System



Metray Telescopic rails with 100% opening and high product carrying capacity are used in all our drawers.

Latch Lock System



Thanks to the latch lock system in each drawer, it prevents unintentional opening of the drawers.

Central Lock System



Central locking system that allows the drawers in the same drawer block to be locked at the same time.

Drawer Carrying Capacity



The carrying capacity of each drawer with telescopic rail system is 95 kg.

Drawer Partition System



There is a metal partition system in the first drawers of each drawer block.

Optional Partition Option



The partition system is offered as an optional option in the drawers.

Cabinet Dimensions

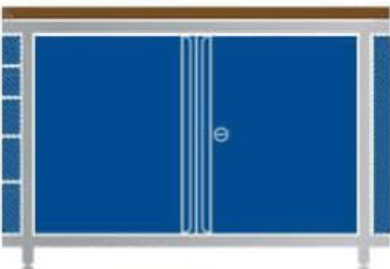

- ▶ Cabinet width: 932 mm
- ▶ Cabinet width: 772 mm

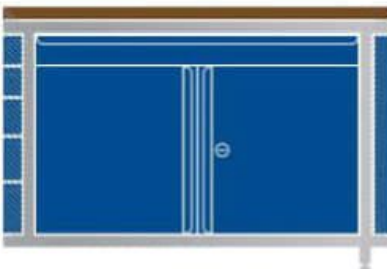

- ▶ Cabinet width: 932 mm
- ▶ Cabinet width: 772 mm

Sliding Shelving System



There are 2 sliding shelves with telescopic rail system in the cabinets located on the work benches.

Shelf Carrying Capacity



The carrying capacity of each shelf with telescopic rail system on work benches is 80 kg.

Locking and Cover System



The cabinets on the workbench have a 95° opening system, the cabinet doors are double-walled.

Countertop Workspace Surface Options

25mm MDF



18 mm MDF on 4 mm Stainless

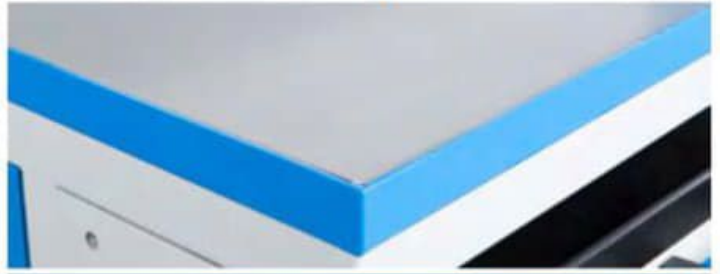

18 mm Chipboard on 2 mm Stainless (with Pool)



Laminate Coating on 30 mm MDF



25 mm Water Contra

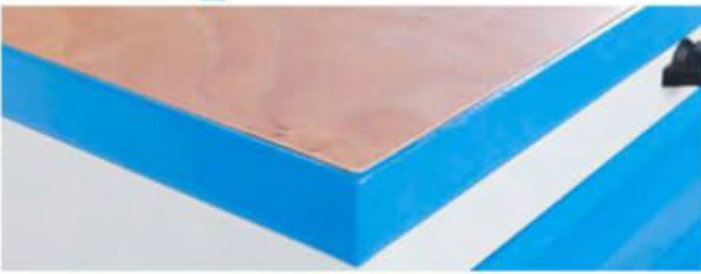

5 mm Rubber on 25 mm MDF

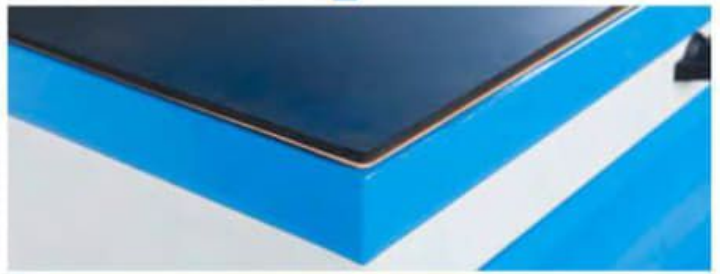

2 mm PVC on 25 mm MDF

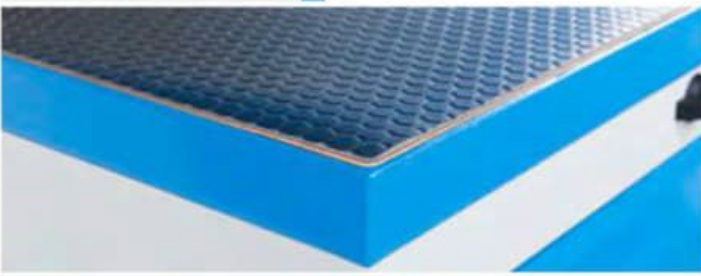

Vise Connection Apparatus

Vise Connection Apparatus



In our bench models, which were developed to maximize the usage area on the bench, clamp connection apparatuses can be attached to the right or left sides of the bench.

Profile Workbenches





Lighting

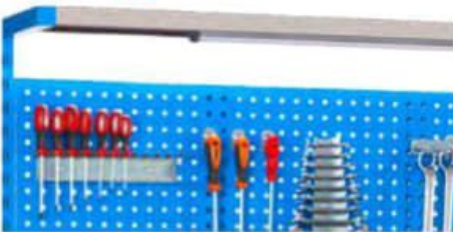

Projecting in accordance with the dimensions of the workbench provides a brighter worktop environment with LED luminaires made of chrome sheet metal.

Team Hanging Board



It provides a more efficient working environment by arranging your generally used hand tools on the tool hanging board and prevents time loss.

Tool Rack



It provides ease of use and organization of hardware materials such as tool boxes and spray cans.

socket

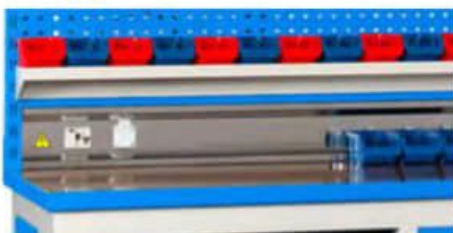

220V sockets with leakage current switch, made of chrome sheet, which provides comfort in the use of your electrical materials, optional 380V socket option.

Sliding Shelving System



There are 2 sliding shelves with telescopic rail system in the cabinets in the profile work benches.

Adjustable Feet



Chrome-plated legs that can be adjusted independently of each other so that the stance balance of the workbench is not affected by floor irregularities.

Electrostatic Powder Coating



All of our products are painted with electrostatic powder paint. Two different paint technologies, smooth and rough, are used.

Wide Color Choice



Freedom to choose the desired color with a wide range of standard colors and corporate color options.

Hanger Bracket



Along with the work benches, 33 hangers in various models are provided.

Profile Workbench A-18 125



Drawer Quantity and Dimensions: 2x85 + 4x100 + 2x132 + 2x173 mm



Profile Workbench A-10.128

Width 4420 mm Depth 720mm Board Load 1100mm Bench Load 900mm



► Drawer Quantity and Dimensions: 5x85 + 4x100 + 2x132 + 2x173 mm

Profile Workbench A-10.130

Width 4250 mm Depth 720 mm Panel Load 900 mm Bench Load 900 mm



► Drawer Quantity and Dimensions: 5x85 + 4x100 + 2x132 + 2x173 + 8x258 mm

Profile Workbench A-10.132

Width 4250 mm Depth 720mm Board Load 1100mm Bench Load 900mm



► Drawer Quantity and Dimensions: 5x85 + 6x258 mm

► Tool Trolley Drawer Quantity and Dimensions: 4x100 + 2x205 mm

Profile Workbench A-10.134

Width 4420 mm Depth 720 mm Panel Load 900 mm Bench Load 900 mm



► Drawer Quantity and Dimensions: 1x85 + 2x100 + 1x132 + 1x173 mm

► Tool Trolley Drawer Quantity and Dimensions: 3x100 + 1x205 mm

Profile Workbench A-10.230

Width 4420 mm Depth 720mm Board Load 240mm Bench Load 900mm



► Drawer Quantity and Dimensions: 2x85 + 4x100 + 2x132 + 2x173 mm

Profile Workbench A-10.232

Width 4250 mm Depth 720 mm Board Load 240mm Bench Load 900mm



► Drawer Quantity and Dimensions: 5x85 + 2x258 mm

► Tool Trolley Drawer Quantity and Dimensions: 4x100 + 2x205 mm

Profile Workbench A 10.138

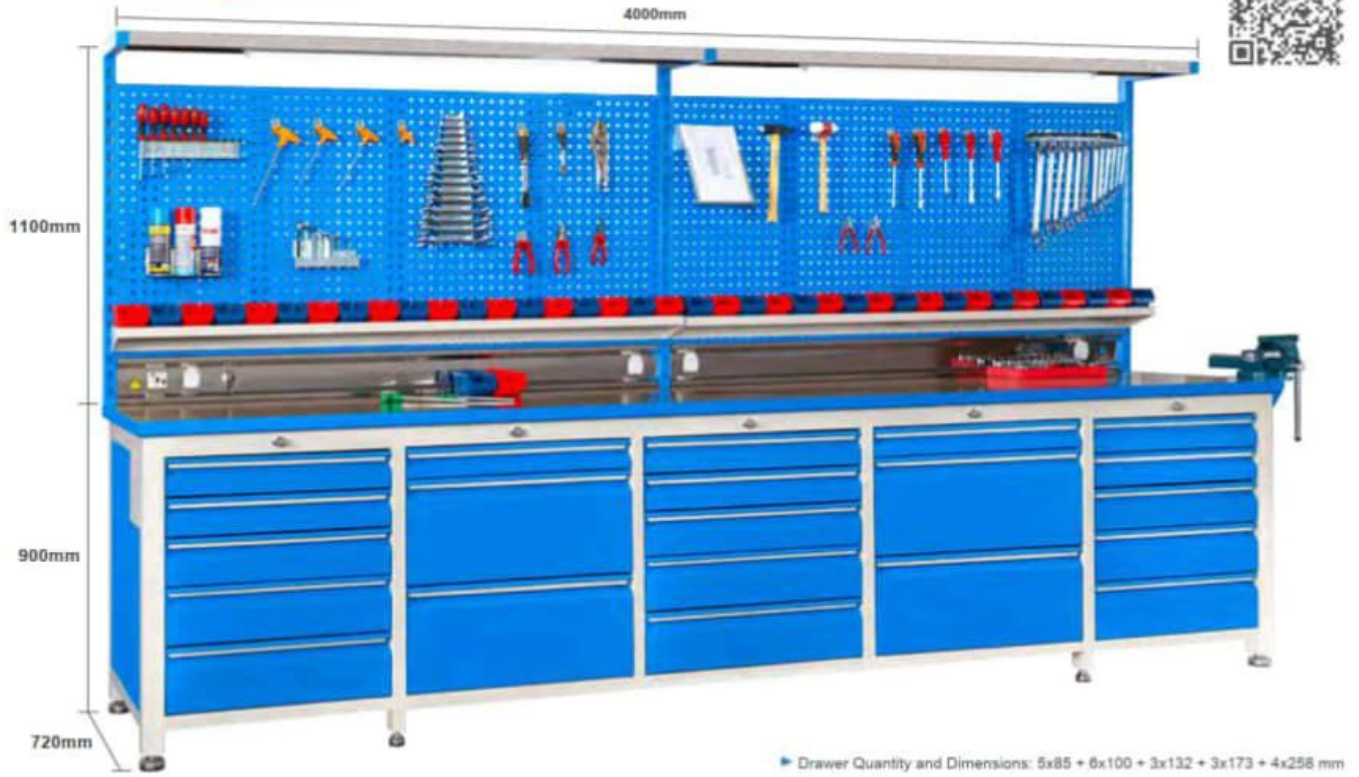

Profile Workbench A-10.136

Width: 4160 mm Depth: 720mm Board Load: 1100mm Bench Load: 900mm



► Drawer Quantity and Dimensions: 3x85 + 6x100 + 3x132 + 3x173 mm

Profile Workbench A-10.140

Width: 4160 mm Depth: 720 mm Panel Load: 900 mm Bench Load: 900 mm



► Drawer Quantity and Dimensions: 3x85 + 2x100 + 1x132 + 1x173 mm

► Tool Trolley Drawer Quantity and Dimensions: 4x100 + 2x205 mm

Profile Workbench A-10.142

Width: 4160 mm Depth: 720mm Board Load: 1100mm Bench Load: 900mm



► Drawer Quantity and Dimensions: 2x85 + 4x100 + 2x132 + 2x173 mm

► Tool Trolley Drawer Quantity and Dimensions: 3x100 + 2x205 mm

Profile Workbench A-10.144

Width: 4160 mm Depth: 720 mm Panel Load: 900 mm Bench Load: 900 mm



► Drawer Quantity and Dimensions: 5x85 + 6x100 + 3x132 + 3x173 mm

Profile Workbench A-10.204

Width: 3860 mm Depth: 720mm Board Load: 1100mm Bench Load: 900mm



► Drawer Quantity and Dimensions: 4x85 + 4x100 + 2x132 + 2x173 mm

Profile Workbench A-10.234

Width: 4160 mm Depth: 720 mm Panel Load: 900 mm Bench Load: 900 mm



► Drawer Quantity and Dimensions: 3x85 + 6x100 + 3x132 + 3x173 mm

Profile Workbench A-10 18

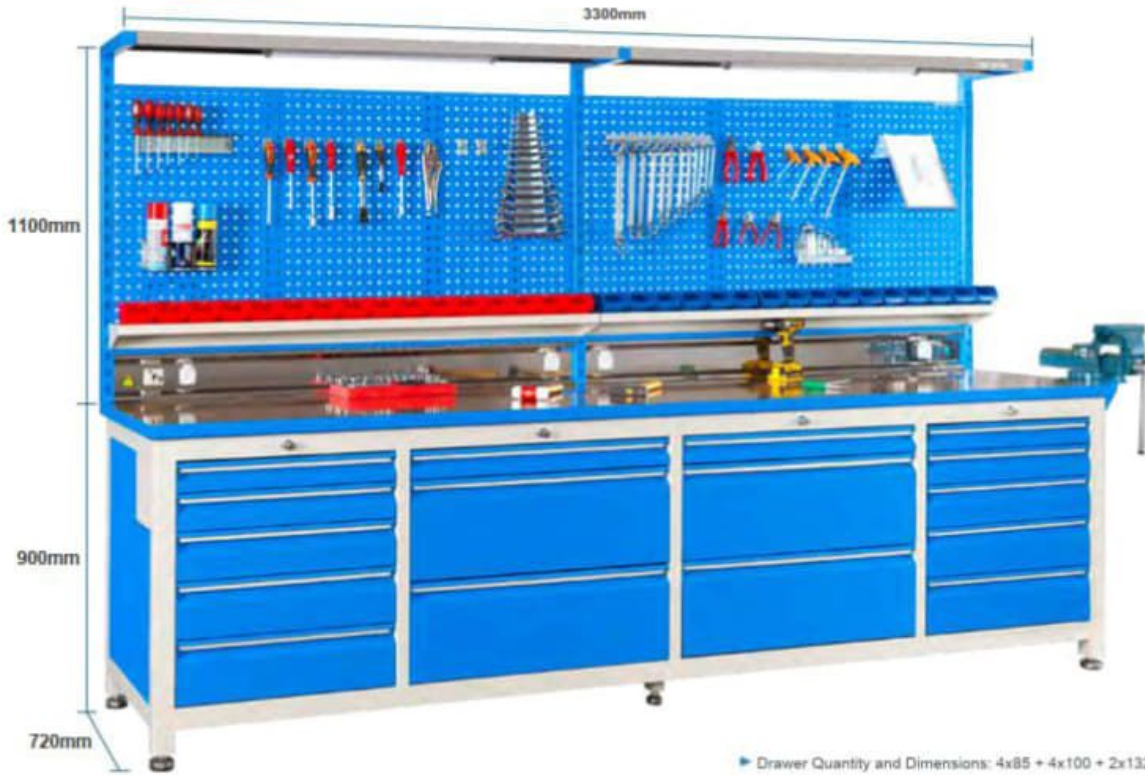

► Drawer Quantity and Dimensions: 4x85 + 4x100 + 2x132 + 2x173 + 4x258 mm



Profile Workbench A-10.104

Width 3450 mm Depth 720mm Board Load 1100mm Bench Load 900mm



► Drawer Quantity and Dimensions: 2x85 + 4x100 + 2x132 + 2x173 mm

Profile Workbench A-10.146

Width 3450 mm Depth 720 mm Panel Load 900 mm Bench Load 900 mm



► Drawer Quantity and Dimensions: 4x85 + 4x100 + 2x132 + 2x173 mm

Profile Workbench A-15.100

Width 2900 mm Depth 720mm Board Load 1100mm Bench Load 900mm



► Drawer Quantity and Dimensions: 4x85 + 4x100 + 2x132 + 2x173 + 4x258 mm

Profile Workbench A-10.121

Width 3450 mm Depth 720 mm Panel Load 900 mm Bench Load 900 mm



► Drawer Quantity and Dimensions: 1x85 + 2x100 + 1x132 + 1x173 mm
 ► Tool Trolley Drawer Quantity and Dimensions: 3x100 + 1x205 mm

Profile Workbench A-15.890

Width 2900 mm Depth 720mm Board Load 1100mm Bench Load 900mm



► Drawer Quantity and Dimensions: 2x85 + 4x100 + 2x132 + 2x173 mm

Profile Workbench A-15.962

Width 2900 mm Depth 720mm Board Load 1100mm Bench Load 900mm



► Drawer Quantity and Dimensions: 2x85 + 4x100 + 2x132 + 2x173 mm

Profile Workbench A-16 08

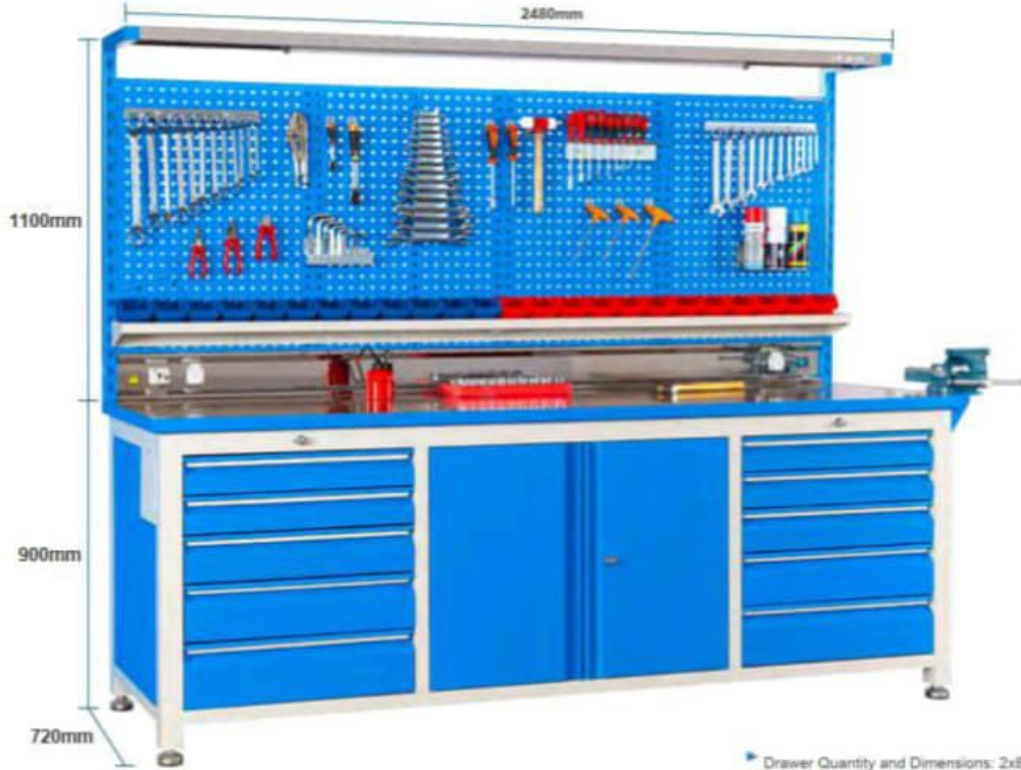

Drawer Quantity and Dimensions: 2x85 + 4x100 + 2x132 + 2x173 mm



Profile Workbench A-16.154

Width 2500 mm Depth 720mm Board Load 1100mm Bench Load 900mm



► Drawer Quantity and Dimensions: 3x85 + 4x100 + 2x132 + 2x173 + 2x258 mm

Profile Workbench A-15.152

Width 2300 mm Depth 720 mm Panel Load 900 mm Bench Load 900 mm



► Drawer Quantity and Dimensions: 3x85 + 4x100 + 2x132 + 2x173 + 2x258 mm

Profile Workbench A-15.150

Width 2250 mm Depth 720mm Board Load 1100mm Bench Load 900mm



► Drawer Quantity and Dimensions: 3x85 + 4x100 + 2x132 + 2x173 mm

Profile Workbench A-15.514

Width 2250 mm Depth 720 mm Panel Load 900 mm Bench Load 900 mm



► Drawer Quantity and Dimensions: 2x85 + 4x100 + 2x132 + 2x173 mm

Profile Workbench A-15.514

Width 2080 mm Depth 720mm Board Load 1100mm Bench Load 900mm



► Drawer Quantity and Dimensions: 2x85 + 4x100 + 2x132 + 2x173 mm

Profile Workbench A-10.206

Width 2480 mm Depth 720 mm Panel Load 900 mm Bench Load 900 mm



► Drawer Quantity and Dimensions: 2x85 + 2x100 + 1x132 + 1x173 mm

Profile Workbench A-18.214

Width: 2480 mm Depth: 720mm Board Load: 1100mm Bench Load: 900mm



- ▶ Drawer Quantity and Dimensions: 1x85 + 2x100 + 1x132 + 1x173 mm
- ▶ Tool Trolley Drawer Quantity and Dimensions: 3x100 + 1x205 mm

Profile Workbench A-18.100

Width: 2420 mm Depth: 720 mm Panel Load: 900 mm Bench Load: 900 mm



- ▶ Drawer Quantity and Dimensions: 2x85 + 2x100 + 1x132 + 1x173 + 2x258 mm
- ▶ Tool Trolley Drawer Quantity and Dimensions: 3x100 + 1x205 mm

Profile Workbench A-18.189

Width: 2480 mm Depth: 720mm Board Load: 1100mm Bench Load: 900mm



- ▶ Drawer Quantity and Dimensions: 2x85 + 2x100 + 1x132 + 1x173 mm
- ▶ Tool Trolley Drawer Quantity and Dimensions: 3x100 + 1x205 mm

Profile Workbench A-15.602

Width: 2200 mm Depth: 720 mm Panel Load: 900 mm Bench Load: 900 mm



- ▶ Drawer Quantity and Dimensions: 1x85 + 2x100 + 1x132 + 1x173 mm
- ▶ Tool Trolley Drawer Quantity and Dimensions: 3x100 + 1x205 mm

Profile Workbench A-18.272

Width: 2480 mm Depth: 720mm Board Load: 1100mm Bench Load: 900mm



- ▶ Drawer Quantity and Dimensions: 2x85 + 2x100 + 1x132 + 1x173 mm

Profile Workbench A-15.702

Width: 2200 mm Depth: 720 mm Panel Load: 900 mm Bench Load: 900 mm



- ▶ Drawer Quantity and Dimensions: 1x85 + 2x100 + 1x132 + 1x173 mm
- ▶ Tool Trolley Drawer Quantity and Dimensions: 3x100 + 1x205 mm

Profile Workbench A-10.154

Width 2500 mm Depth 720mm Board Load 1100mm Bench Load 900mm



► Drawer Quantity and Dimensions: 3x85 + 4x100 + 2x132 + 2x173 + 2x258 mm

Profile Workbench A-10.155

Width 2480 mm Depth 720 mm Board Load 1100 mm Bench Load 900 mm



► Drawer Quantity and Dimensions: 3x85 + 4x100 + 2x132 + 2x173 mm

Profile Workbench A-10.148

Width 2240 mm Depth 720mm Board Load 1100mm Bench Load 900mm



► Drawer Quantity and Dimensions: 2x85 + 4x100 + 2x132 + 2x173 mm

Profile Workbench A-10.876

Width 2480 mm Depth 720 mm Board Load 1100 mm Bench Load 900 mm



► Drawer Quantity and Dimensions: 2x85 + 4x100 + 2x132 + 2x173 mm

Profile Workbench A-10.874

Width 2480 mm Depth 720mm Board Load 1100mm Bench Load 900mm



► Drawer Quantity and Dimensions: 2x85 + 4x100 + 2x132 + 2x173 mm

Profile Workbench A-10.872

Width 2480 mm Depth 720mm Board Load 1240mm Bench Load 900mm



► Drawer Quantity and Dimensions: 2x85 + 4x100 + 2x132 + 2x173 mm

Profile Workbench A-10.112

Width: 2760 mm Depth: 720mm Board Load: 1100mm Bench Load: 900mm



► Drawer Quantity and Dimensions: 1x85 + 2x100 + 1x132 + 1x173 mm

Profile Workbench A-15.322

Width: 2760 mm Depth: 90 mm Panel Load: 90 mm Bench Load: 900 mm



► Drawer Quantity and Dimensions: 3x85 + 2x100 + 1x132 + 1x173 mm

Profile Workbench A-10.112

Width: 2700 mm Depth: 720mm Board Load: 1100mm Bench Load: 900mm



► Drawer Quantity and Dimensions: 3x85 + 2x100 + 1x132 + 1x173 + 4x258 mm

Profile Workbench A-10.120

Width: 2600 mm Depth: 90 mm Panel Load: 90 mm Bench Load: 900 mm



► Drawer Quantity and Dimensions: 3x85 + 2x100 + 1x132 + 1x173 + 4x258 mm

Profile Workbench A-15.512

Width: 2300 mm Depth: 720mm Board Load: 1100mm Bench Load: 900mm



► Drawer Quantity and Dimensions: 1x85 + 2x100 + 1x132 + 1x173 mm

Profile Workbench A-15.116

Width: 2300 mm Depth: 90 mm Panel Load: 90 mm Bench Load: 900 mm



► Drawer Quantity and Dimensions: 3x85 + 2x100 + 1x132 + 1x173 + 4x258 mm

Profile Workbench A-15.310

Width: 2300 mm Depth: 720mm Board Load: 1100mm Bench Load: 900mm



► Drawer Quantity and Dimensions: 3x85 + 2x100 + 1x132 + 1x173 mm

Profile Workbench A-10.116

Width: 2200 mm Depth: 720 mm Board Load: 900 mm Bench Load: 900 mm



► Drawer Quantity and Dimensions: 3x85 + 6x100 + 3x132 + 3x173 mm

Profile Workbench A-15.312

Width: 2200 mm Depth: 720mm Board Load: 1100mm Bench Load: 900mm



► Drawer Quantity and Dimensions: 1x85 + 2x100 + 1x132 + 1x173 mm

Profile Workbench A-15.310

Width: 2200 mm Depth: 720 mm Board Load: 900 mm Bench Load: 900 mm



► Drawer Quantity and Dimensions: 3x85 + 2x100 + 1x132 + 1x173 mm

Profile Workbench A-15.118

Width: 2100 mm Depth: 720mm Board Load: 1100mm Bench Load: 900mm



► Drawer Quantity and Dimensions: 3x85 + 2x100 + 1x132 + 1x173 + 4x258 mm

Profile Workbench A-15.240

Width: 2300 mm Depth: 720mm Board Load: 240 mm Bench Load: 900mm



► Drawer Quantity and Dimensions: 1x85 + 2x100 + 1x132 + 1x173 mm

Profile Workbench A-10.190

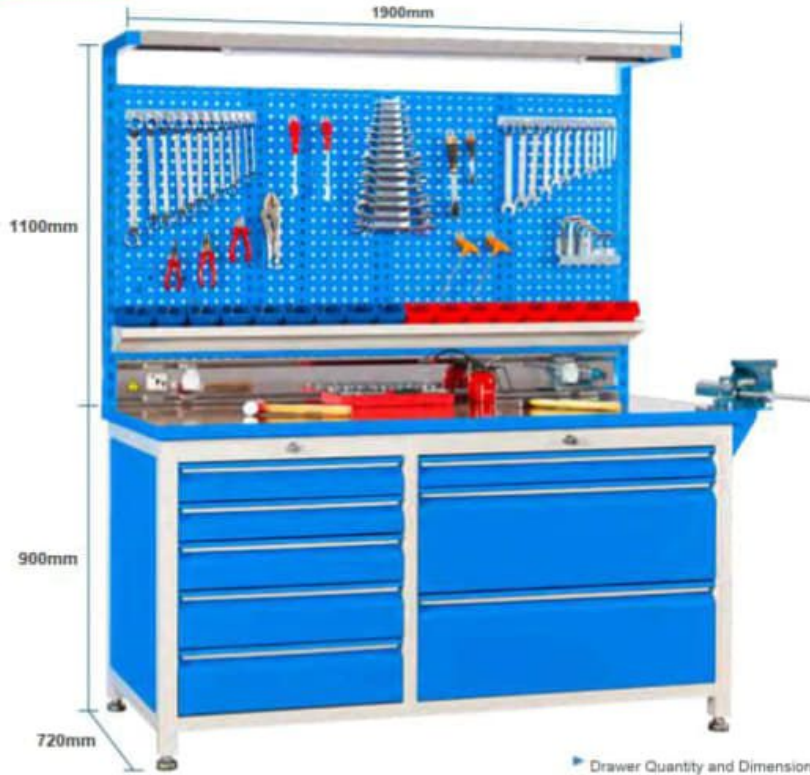

Drawer Quantity and Dimensions: 2x85 + 2x100 + 1x132 + 1x173 + 2x258 mm



Profile Workbench A-18.110

Width 1765mm Depth 720mm Board Load 1100mm Bench Load 900mm



► Drawer Quantity and Dimensions: 1x85 + 2x100 + 1x132 + 1x173 mm

Profile Workbench A-18.164

Width 1765mm Depth 900mm Board Load 1100mm Bench Load 900mm



► Drawer Quantity and Dimensions: 2x85 + 2x100 + 1x132 + 1x173 mm

Profile Workbench A-18.112

Width 1700mm Depth 720mm Board Load 1100mm Bench Load 900mm



► Drawer Quantity and Dimensions: 2x85 + 2x100 + 1x132 + 1x173 + 2x258 mm

Profile Workbench A-15.194

Width 1500mm Depth 900mm Board Load 1100mm Bench Load 900mm



► Drawer Quantity and Dimensions: 2x85 + 2x100 + 1x132 + 1x173 + 2x258 mm

Profile Workbench A-18.198

Width 1485mm Depth 720mm Board Load 1100mm Bench Load 900mm



► Drawer Quantity and Dimensions: 2x85 + 2x100 + 1x132 + 1x173 mm

Profile Workbench A-15.552

Width 1485mm Depth 900mm Board Load 1100mm Bench Load 900mm



► Drawer Quantity and Dimensions: 1x85 + 2x100 + 1x132 + 1x173 mm

Profile Workbench A-18.796

Width 1765mm Depth 720mm Board Load 1100mm Bench Load 900mm



► Drawer Quantity and Dimensions: 1x85 + 2x100 + 1x132 + 1x173 mm

Profile Workbench A-18.372

Width 1765mm Depth 900mm Panel Load 900mm Bench Load 900mm



► Drawer Quantity and Dimensions: 2x85 + 2x100 + 1x132 + 1x173 mm

Profile Workbench A-18.114

Width 1700mm Depth 720mm Board Load 1100mm Bench Load 900mm



► Drawer Quantity and Dimensions: 2x85 + 2x100 + 1x132 + 1x173 + 2x258 mm

Profile Workbench A-15.178

Width 1500mm Depth 900mm Panel Load 900mm Bench Load 900mm



► Drawer Quantity and Dimensions: 2x85 + 2x100 + 1x132 + 1x173 + 2x258 mm

Profile Workbench A-15.790

Width 1485mm Depth 720mm Board Load 1100mm Bench Load 900mm



► Drawer Quantity and Dimensions: 2x85 + 2x100 + 1x132 + 1x173 mm

Profile Workbench A-15.176

Width 1485mm Depth 900mm Panel Load 900mm Bench Load 900mm



► Drawer Quantity and Dimensions: 1x85 + 2x100 + 1x132 + 1x173 mm

Profile Workbench A-15.106

Width 1300 mm Depth 720mm Board Load 1100 mm Bench Load 900mm



► Drawer Quantity and Dimensions: 2x85 + 2x100 + 1x132 + 1x173 + 2x258 mm

Profile Workbench A-15.540

Width 1250 mm Depth 720 mm Panel Load 900 mm Bench Load 900 mm



► Drawer Quantity and Dimensions: 2x85 + 4x100 + 2x132 + 2x173 mm

Profile Workbench A-15.836

Width 1180 mm Depth 720mm Board Load 1100mm Bench Load 900mm



► Drawer Quantity and Dimensions: 1x85 + 2x100 + 1x132 + 1x173 mm

Profile Workbench A-15.560

Width 1000mm Depth 720mm Board Load 1100mm Bench Load 900mm



► Drawer Quantity and Dimensions: 1x85 + 2x100 + 1x132 + 1x173 mm

Profile Workbench A-15.212

Width 1755mm Depth 720mm Board Load 500mm Bench Load 900mm



► Drawer Quantity and Dimensions: 1x85 + 2x100 + 1x132 + 1x173 mm

Profile Workbench A-15.226

Width 1000mm Depth 720 mm Panel Load 900 mm Bench Load 900 mm



► Drawer Quantity and Dimensions: 1x85 + 2x100 + 1x132 + 1x173 mm

Profile Workbench A-15.706



Drawer Quantity and Dimensions: 4x85 + 4x100 + 2x132 + 2x173 + 4x155 + 4x258 mm



Profile Workbench A-15.752

Width 2200x2200 mm Depth 720mm Board Load 1100mm Bench Load 900mm



► Drawer Quantity and Dimensions: 2x85 + 4x100 + 2x132 + 2x173 mm

Profile Workbench A-15.758

Width 2450x2450 mm Depth 720mm Board Load 1100mm Bench Load 900mm



► Drawer Quantity and Dimensions: 2x85 + 4x100 + 2x132 + 2x173 mm

Profile Workbench A-15.768

Width 2200x2200 mm Depth 720mm Board Load 1100mm Bench Load 900mm



► Drawer Quantity and Dimensions: 4x85 + 4x100 + 2x132 + 2x173 + 4x258 mm

Profile Workbench A-15.200



► Drawer Quantity and Dimensions: 3x100 + 1x205 mm



Profile Workbench A-15.862

Width 1450 mm Depth 720mm Board Load 1100mm Bench Load 900mm



► Drawer Quantity and Dimensions: 2x100 + 1x205 mm

Profile Workbench A-15.864

Width 1820 mm Depth 350 mm Board Load 1100mm Bench Load 820mm



► Drawer Quantity and Dimensions: 3x100 mm

Profile Workbench A-15.866

Width 1820 mm Depth 350 mm Board Load 1100mm Bench Load 820mm



► Drawer Quantity and Dimensions: 1x100 mm

Profile Workbench A-15.868

Width 2000mm Depth 350 mm Board Load 1100mm Bench Load 880mm



► Drawer Quantity and Dimensions: 1x100 mm

Profile Workbench

4420 mm 720mm 1100mm 900mm

Drawer Quantity and Dimensions: 6x100 + 2x125 + 2x150 + 2x175 mm

Tool Trolley Drawer Quantity and Dimensions: 6x100 + 2x125 + 2x150 + 2x175 mm

Profile Workbench

2000mm 720 mm 1100 mm 900mm

Drawer Quantity and Dimensions: 1x100 mm

Octagonal Workbench 8-10.8.2



► Drawer Quantity and Dimensions: 4x85 + 4x100 + 2x132 + 2x173 mm



Octagonal Work Table A-15,802

Width 1500 mm Depth 1500 mm Height 1000 mm



► Drawer Quantity and Dimensions: 4x85 + 8x100 + 4x132 + 4x173 mm

Octagonal Workbench A-15,814

Width 1500 mm Depth 1500 mm Height 1000 mm



► Drawer Quantity and Dimensions: 4x85 mm

Hexagonal Work Table A-15,810

Width 1585 mm Depth 585 mm Height 1000 mm



► Drawer Quantity and Dimensions: 3x85 mm

Octagonal Workbench A-15806

Width 1500 mm Depth 1500 mm Height 1000 mm



► Drawer Quantity and Dimensions: 2x85 + 4x100 + 2x132 + 2x173 mm

Hexagonal Work Table A-15,804

Width 2000mm Depth 300mm Height 1000mm



► Drawer Quantity and Dimensions: 2x85 + 4x100 + 2x132 + 2x173 mm

Hexagonal Workbench A-15,808

Width 2000mm Depth 300mm Height 1000mm



► Drawer Quantity and Dimensions: 3x85 + 6x100 + 3x132 + 3x173 mm

Modular Workbench





Lighting

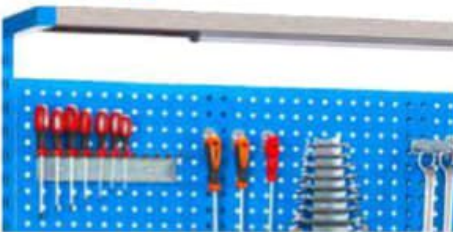

Projecting in accordance with the dimensions of the workbench provides a brighter worktop environment with LED luminaires made of chrome sheet metal.

Team Hanging Board

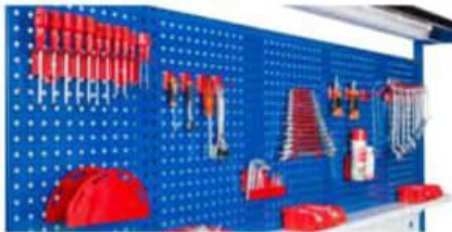

It provides a more efficient working environment by arranging your generally used hand tools on the tool hanging board and prevents time loss.

Tool Rack



It provides ease of use and organization of hardware materials such as tool boxes and spray cans.

socket

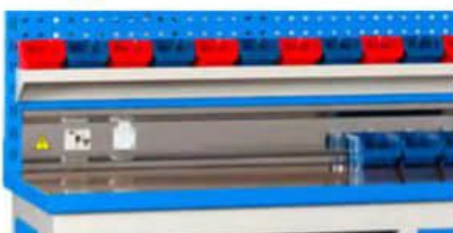

220V sockets with leakage current switch, made of chrome sheet, which provides comfort in the use of your electrical materials, optional 380V socket option.

Adjustable Shelf System



In the workbench cabinets, there is 1 height adjustable shelf in each cabinet.

Adjustable Feet



Chrome-plated legs that can be adjusted independently of each other so that the stance balance of the workbench is not affected by floor irregularities.

Electrostatic Powder Coating



All of our products are painted with electrostatic powder paint. Two different paint technologies, smooth and rough, are used.

Wide Color Choice



Freedom to choose the desired color with a wide range of standard colors and corporate color options.

Hanger Bracket



Along with the work benches, 33 hangers in various models are provided.

Modular Workbench B-20 182



Modular Workbench B-20.104

Width 3370 mm Depth 720mm Board Load 1100mm Bench Load 900mm



► Drawer Quantity and Dimensions: 2 x 100 + 4 x 150 + 2 x 205 mm

Modular Workbench B-20.124

Width 2570 mm Depth 720mm Board Load 1100mm Bench Load 900mm



► Drawer Quantity and Dimensions: 2 x 100 + 4 x 150 + 2 x 205 mm

Modular Workbench B-20.100

Width 2640 mm Depth 720mm Board Load 1100mm Bench Load 900mm



► Drawer Quantity and Dimensions: 1 x 100 + 2 x 150 + 1 x 205 mm

Modular Workbench B-20.120

Width 2520 mm Depth 720mm Board Load 1100mm Bench Load 900mm



► Drawer Quantity and Dimensions: 1 x 100 + 2 x 150 + 1 x 205 mm

Modular Workbench B-20.110

Width 2440 mm Depth 720mm Board Load 1100mm Bench Load 900mm



► Drawer Quantity and Dimensions: 2 x 100 + 4 x 150 + 2 x 205 mm

Modular Workbench B-23.102

Width 2440 mm Depth 720mm Board Load 1100mm Bench Load 900mm



► Drawer Quantity and Dimensions: 2 x 100 + 4 x 150 + 2 x 205 mm

Modular Workbench B-20.140

Width 2240 mm Depth 720mm Board Load 1100mm Bench Load 900mm



► Drawer Quantity and Dimensions: 1 x 100 + 2 x 150 + 1 x 205 mm

Modular Workbench B-20.130

Width 2240 mm Depth 720mm Board Load 1100mm Bench Load 900mm



► Drawer Quantity and Dimensions: 2 x 100 + 4 x 150 + 2 x 205 mm

Modular Workbench B-20.112

Width 2240 mm Depth 720mm Board Load 1100mm Bench Load 900mm



► Drawer Quantity and Dimensions: 3 x 100 + 6 x 150 + 3 x 205 mm

Modular Workbench B-20.128

Width 2200 mm Depth 720mm Board Load 1100mm Bench Load 900mm



► Drawer Quantity and Dimensions: 2 x 100 + 4 x 150 + 2 x 205 mm

Modular Workbench B-20.132

Width 2120 mm Depth 720mm Board Load 1100mm Bench Load 900mm



► Drawer Quantity and Dimensions: 1 x 100 + 2 x 150 + 1 x 205 mm

Modular Workbench B-20.134

Width 2120 mm Depth 720mm Board Load 1100mm Bench Load 900mm



► Drawer Quantity and Dimensions: 1 x 100 + 2 x 150 + 1 x 205 mm

Modular Workbench B-20.134

Width 2000mm Depth 720mm Board Load 1100mm Bench Load 900mm



► Drawer Quantity and Dimensions: 2 x 100 + 4 x 150 + 2 x 205 mm

Modular Workbench B-20.148

Width 2000mm Depth 720mm Board Load 1100mm Bench Load 900mm



► Drawer Quantity and Dimensions: 1 x 100 + 2 x 150 + 1 x 205 mm

Modular Workbench B-20.158

Width 1700mm Depth 720mm Board Load 1100mm Bench Load 900mm



► Drawer Quantity and Dimensions: 1 x 100 + 2 x 150 + 1 x 205 mm

Modular Workbench B-20.162

Width 1500mm Depth 720mm Board Load 1100mm Bench Load 900mm



► Drawer Quantity and Dimensions: 1 x 100 + 2 x 150 + 1 x 205 mm

Modular Workbench B-20.158

Width 1390mm Depth 720mm Board Load 1100mm Bench Load 900mm



► Drawer Quantity and Dimensions: 1 x 100 + 2 x 150 + 1 x 205 mm

Modular Workbench B-20.160

Width 1270mm Depth 720mm Board Load 1100mm Bench Load 900mm



► Drawer Quantity and Dimensions: 1 x 100 + 2 x 150 + 1 x 205 mm

Modular Workbench B-21.202



► Drawer Quantity and Dimensions: 2 x 100 + 4 x 150 + 2 x 205 mm



Modular Workbench B-20.104

Width 2200 mm Depth 720mm Board Load 1100mm Bench Load 900mm



► Drawer Quantity and Dimensions: 1 x 100 + 2 x 150 + 1 x 205 mm

Modular Workbench B-20.114

Width 2200 mm Depth 720mm Board Load 1100mm Bench Load 900mm



► Drawer Quantity and Dimensions: 1 x 100 + 2 x 150 + 1 x 205 mm

Modular Workbench B-20.185

Width 1500 mm Depth 720mm Board Load 1100mm Bench Load 900mm



► Drawer Quantity and Dimensions: 3 x 100 + 1 x 205 mm

Modular Workbench B-20.190

Width 1500 mm Depth 720mm Board Load 1100mm Bench Load 900mm



► Drawer Quantity and Dimensions: 3 x 100 + 1 x 205 mm

Modular Workbench B-20.194

Width 1900mm Depth 720mm Bench Load 900mm



► Drawer Quantity and Dimensions: 1 x 100 + 2 x 150 + 1 x 205 mm

Modular Workbench B-20.208

Width 2000mm Depth 720mm Bench Load 900mm



► Drawer Quantity and Dimensions: 1 x 100 + 2 x 150 + 1 x 205 mm

Monoblock Workbench B-74.284



Drawer Quantity and Dimensions: 4x85 + 4x100 + 2x132 + 2x173 + 4x258 mm



Monoblock Workbench B-24.200

Width 2600 mm Depth 720mm Board Load 1100mm Bench Load 900mm



► Drawer Quantity and Dimensions: 4x85 + 4x100 + 2x132 + 2x173 + 4x258 mm

Monoblock Workbench B-24.240

Width 2400 mm Depth 720mm Board Load 1100mm Bench Load 900mm



► Drawer Quantity and Dimensions: 3x85 + 2x100 + 1x132 + 1x173 + 4x258 mm

Monoblock Workbench B-24.220

Width 2200 mm Depth 720mm Board Load 1100mm Bench Load 900mm



► Drawer Quantity and Dimensions: 3x85 + 4x100 + 2x132 + 2x173 + 2x258 mm

Monoblock Workbench B-24.209

Width 2000mm Depth 720mm Board Load 1100mm Bench Load 900mm



► Drawer Quantity and Dimensions: 2x85 + 2x100 + 1x132 + 1x173 + 2x258 mm

Monoblock Workbench B-24.180

Width 1800mm Depth 720mm Board Load 1100mm Bench Load 900mm



► Drawer Quantity and Dimensions: 2x85 + 2x100 + 1x132 + 1x173 + 2x258 mm

Monoblock Workbench B-24.160

Width 1600 mm Depth 720mm Board Load 1100mm Bench Load 900mm



► Drawer Quantity and Dimensions: 2x85 + 2x100 + 1x132 + 1x173 + 2x258 mm

Monoblock Workbench B-20.100

Width 1590 mm Depth 720mm Board Load 1100mm Bench Load 900mm



► Drawer Quantity and Dimensions: 1x85 + 2x100 + 1x132 + 1x173 mm

Monoblock Workbench B-20.115

Width 1550 mm Depth 720mm Board Load 1100mm Bench Load 900mm



► Drawer Quantity and Dimensions: 1x85 + 2x100 + 1x132 + 1x173 mm

Monoblock Workbench B-20.200

Width 1500 mm Depth 720mm Board Load 1100mm Bench Load 900mm



► Drawer Quantity and Dimensions: 2x85 + 2x100 + 1x132 + 1x173 mm

Monoblock Workbench B-20.210

Width 1500 mm Depth 720mm Board Load 1100mm Bench Load 900mm



► Drawer Quantity and Dimensions: 3x85 mm

Monoblock Workbench B-24.140

Width 1400 mm Depth 720mm Board Load 1100mm Bench Load 900mm



► Drawer Quantity and Dimensions: 2x85 + 2x100 + 1x132 + 1x173 + 2x258 mm

Monoblock Workbench B-24.120

Width 1200 mm Depth 720mm Board Load 1100mm Bench Load 900mm



► Drawer Quantity and Dimensions: 2x85 + 2x100 + 1x132 + 1x173 + 2x258 mm

Monoblock Workbench B-20.120

Width 1120 mm Depth 720mm Board Load 1100mm Bench Load 900mm



► Drawer Quantity and Dimensions: 1x85 + 2x100 + 1x132 + 1x173 mm

Monoblock Workbench B-24.100

Width 1000mm Depth 720mm Board Load 1100mm Bench Load 900mm



► Drawer Quantity and Dimensions: 3x100 + 1x335 mm

Monoblock Workbench B-20.122

Width 1000mm Depth 570mm Board Load 1100mm Bench Load 900mm



► Drawer Quantity and Dimensions: 4x100 + 1x205 mm

Monoblock Workbench B-20.202

Width 1500 mm Depth 20 mm Bench Load. mm



► Drawer Quantity and Dimensions: 2x85 + 2x100 + 1x132 + 1x173 mm

Monoblock Workbench B-24.204

Width 1400 mm Depth 720mm Board Load 500mm Bench Load 900mm



► Drawer Quantity and Dimensions: 2x85 + 2x100 + 1x132 + 1x173 + 2x258 mm

Monoblock Workbench B-20.154

Width 1120 mm Depth 720mm Bench Load 900mm



► Drawer Quantity and Dimensions: 1x85 + 2x100 + 1x132 + 1x173 mm

Disassembled Workbench C 25_356



Disassembled Workbench C-25,354

Width 2200 mm Depth 700mm Board Load 1100mm Bench Load 900mm



► Drawer Quantity and Dimensions: 5x100 + 1x205 mm

Disassembled Workbench C-25,358

Width 2200 mm Depth 700mm Board Load 1100mm Bench Load 900mm



► Drawer Quantity and Dimensions: 5x100 + 1x205 mm

Demountable Workbench C-25,102

Width 2200 mm Depth 700mm Board Load 1100mm Bench Load 900mm



► Drawer Quantity and Dimensions: 2x100 + 1x205 mm

Demountable Workbench C-25,360

Width 2200 mm Depth 700mm Board Load 1100mm Bench Load 900mm



► Drawer Quantity and Dimensions: 5x100 mm

Disassembled Workbench C-25,106

Width 2200 mm Depth 720mm Board Load 1100mm Bench Load 900mm



► Drawer Quantity and Dimensions: 2 x 100 mm

Disassembled Workbench C-25,112

Width 1700 mm Depth 700mm Board Load 1100mm Bench Load 900mm



► Drawer Quantity and Dimensions: 2x100 mm

Disassembled Workbench C-25.304

Width 2200 mm Depth 700mm Height 900mm



► Drawer Quantity and Dimensions: 5x100 + 1x205 mm

Disassembled Work Bench C-25.310

Width 2200 mm Depth 700mm Height 900mm



► Drawer Quantity and Dimensions: 6x100 mm

Disassembled Workbench C-25.308

Width 2200 mm Depth 700mm Height 900mm



► Drawer Quantity and Dimensions: 6x100 mm

Disassembled Work Bench C-25.312

Width 2200 mm Depth 700mm Height 900mm



► Drawer Quantity and Dimensions: 6x100 mm

Disassembled Workbench C-25.306

Width 2200 mm Depth 700 mm Height 900 mm



► Drawer Quantity and Dimensions: 2x100 mm

Disassembled Work Bench

Width 2200 mm Depth 720 mm Height 900 mm

► Drawer Quantity and Dimensions: 3 x 100 + 1 x 205 mm

Disassembled Workbench C-25,402

Width 2200 mm Depth 700mm Height 800mm



► Drawer Quantity and Dimensions: 2x100 + 1x205 mm

Disassembled Work Bench C-25,404

Width 2200 mm Depth 700mm Height 800mm

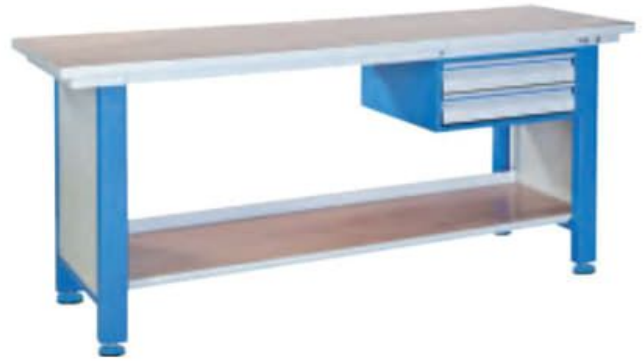

► Drawer Quantity and Dimensions: 2x100 mm

Disassembled Workbench C-25,412

Width 2200 mm Depth 700mm Height 800mm

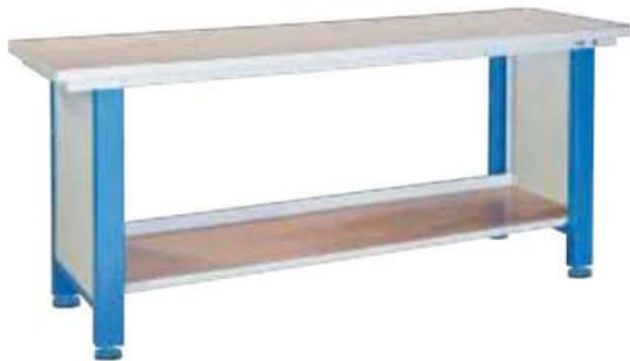

► Drawer Quantity and Dimensions: -

Disassembled Work Bench C-25,406

Width 1700 mm Depth 700mm Height 800mm



► Drawer Quantity and Dimensions: 2x100 + 1x205 mm

Disassembled Workbench C-25,408

Width 1700 mm Depth 700 mm Height 800 mm



► Drawer Quantity and Dimensions: 2x100 mm

Disassembled Work Bench C-25,410

Width 1700 mm Depth 700 mm Height 800 mm



► Drawer Quantity and Dimensions: -

Electrician and Electronics Workbench 3-25.102

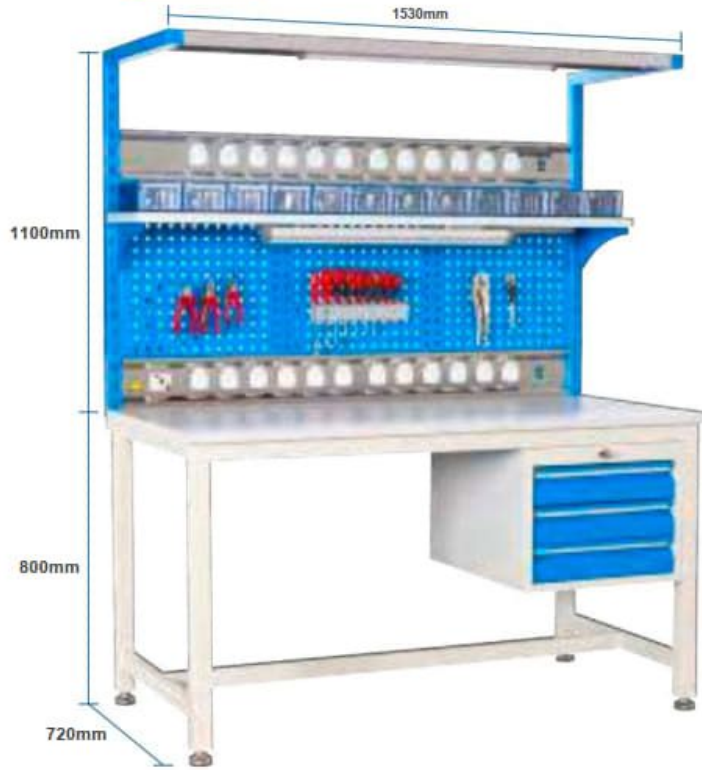

► Drawer Quantity and Dimensions: 3x100 mm



Electrician and Electronics Workbench **B-25.112**

Width 1800mm Depth 720mm Board Load 1100mm Bench Load 800mm



► Drawer Quantity and Dimensions: 3x100 mm

Electrician and Electronics Workbench **B-25.104**

Width 1530 mm Depth 720mm Board Load 1100mm Bench Load 800mm



► Drawer Quantity and Dimensions: 3x100 + 1x200 mm

Electrician and Electronics Workbench **B-25.116**

Width 1500 mm Depth 720mm Board Load 1220 mm Bench Load 780mm



► Drawer Quantity and Dimensions: 4x80 + 1x160 mm

Electrician and Electronics Workbench **B-25.118**

Width 1500 mm Depth 720mm Board Load 1220 mm Bench Load 780mm



► Drawer Quantity and Dimensions: 4x80 + 1x160 mm

Electrician and Electronics Workbench **B-25.114**

Width 1700 mm Depth 720mm Board Load 645 mm Bench Load 850mm



► Drawer Quantity and Dimensions: 5x100 mm

Electrician and Electronics Workbench **B-25.120**

Width 2000mm Depth 720mm Board Load 1100 mm Bench Load 900mm



► Drawer Quantity and Dimensions: 4x100 + 2x200 mm

Team Cars





ABS Table



Tool trolley upper section 12-section ABS table

Plywood Workspace



Tool trolley upper part 10 mm plywood table

Telescopic Rail



Telescopic rail system with 100% opening is used in the drawers. The carrying capacity of a drawer is 35 kg.

Locking System



Central locking system that allows all drawers to be locked at the same time, and a latch lock system that prevents unintentional opening of the drawers.

Drawer Partition System



With the metal partition system, your materials are more organized! There is a metal partition system in the first drawers of each drawer block.

Shelf System



The shelf systems in the tool trolley have a height-adjustable feature. The carrying capacity of a shelf is 60 kg.

wheels



There are 1 swivel brake, 1 swivel and 2 fixed solid wheels in the tool trolleys.

Electrostatic Powder Coating



All of our products are painted with electrostatic powder paint. Two different paint technologies, smooth and rough, are used.

Wide Color Choice



Freedom to choose the desired color with a wide range of standard colors and corporate color options.

Tool Trolleys D-30102



▶ Drawer Quantity and Dimensions: 4x100 + 1x205 mm



Tool Cars **D-30.106**

Width 615 mm Depth 150 mm Height 900 mm



► Drawer Quantity and Dimensions: 1x100 + 2x150 + 1x205 mm

Tool Cars **D-30.108**

Width 725 mm Depth 480 mm Height 900 mm



► Drawer Quantity and Dimensions: 4x100 + 1x205 mm

Tool Trolleys **D-30.104**

Width 615 mm Depth 450 mm Height 900 mm



► Drawer Quantity and Dimensions: 6x75 + 1x150 mm

Tool Cars **D-30.134**

Width 675 mm Depth 150 mm Height 1000 mm



► Drawer Quantity and Dimensions: 7x75 + 1x170 mm

Tool Cars **D-30.142**

Width 615 mm Depth 450 mm Height 800 mm



► Drawer Quantity and Dimensions: 3x100 + 1x205 mm

Tool Cars **D-30.124**

Width 615 mm Depth 450 mm Height 900 mm



► Drawer Quantity and Dimensions: 1x100 mm

Tool Trolleys D-30114



► Drawer Quantity and Dimensions: 7x100 + 1x205 mm



Tool Cars **D-30.110**

Width 615 mm Depth 450 mm Height 1000mm



► Drawer Quantity and Dimensions: 5x100 + 1x205 mm

Tool Cars **D-30.136**

Width 725 mm Depth 480 mm Height 1000mm



► Drawer Quantity and Dimensions: 5x100 + 1x205 mm

Tool Cars **D-30.112**

Width 725 mm Depth 480 mm Height 200mm



► Drawer Quantity and Dimensions: 5x100 + 1x180 mm

Tool Cars **D-30.116**

Width 750 mm Depth 550 mm Height 1030mm



► Drawer Quantity and Dimensions: 6x90 + 1x190 mm

Tool Cars **D-30.144**

Width 750 mm Depth 550 mm Height 1170mm



► Drawer Quantity and Dimensions: 7x100 + 1x150 mm

Tool Cars **D-30.146**

Width 615 mm Depth 550 mm Height 1100mm



► Drawer Quantity and Dimensions: 4x100 + 2x205 mm

Tool Trolleys D-30 118



▶ Drawer Quantity and Dimensions: 3x100 + 1x205 mm



Tool Cars **D-30.140**

Width 675 mm Depth 480 mm Height 900 mm



► Drawer Quantity and Dimensions: 3x75 + 1x205 mm

Tool Cars **D-30.120**

Width 615 mm Depth 450 mm Height 900 mm



► Drawer Quantity and Dimensions: 4x100 mm

Tool Cars **D-30.122**

Width 615 mm Depth 450 mm Height 900 mm



► Drawer Quantity and Dimensions: 2x100 + 1x205 mm

Tool Cars **D-30.132**

Width 725 mm Depth 480 mm Height 900 mm



► Drawer Quantity and Dimensions: 1x100 mm

Tool Cars **D-30.134**

Width 595 mm Depth 450 mm Height 900 mm



► Drawer Quantity and Dimensions: 1x100 mm

Tool Cars **D-30.130**

Width 700 mm Depth 500 mm Height 900 mm



► Drawer Quantity and Dimensions: -

Tool Trolleys D-30204



► Drawer Quantity and Dimensions: 4x100 + 1x205 mm



Tool Cars **D-30.202**

Width 1000mm Depth 500 mm Height 900 mm



► Drawer Quantity and Dimensions: 4x100 + 1x205 mm

Tool Cars **D-30.208**

Width 1000 mm Depth 500 mm Height 900 mm



► Drawer Quantity and Dimensions: 1x100 + 2x150 + 1x205 mm

Tool Cars **D-30.206**

Width 1000 mm Depth 500 mm Height 900 mm



► Drawer Quantity and Dimensions: 1x100 + 2x150 + 1x205 mm

Tool Cars **D-30.210**

Width 1040 mm Depth 520 mm Height 900 mm



► Drawer Quantity and Dimensions: 1x100 + 2x150 + 1x205 mm

Tool Cars **D-30.148**

Width 1000 mm Depth 620 mm Height 915 mm



► Drawer Quantity and Dimensions: 4x100 + 1x205 mm

Tool Trolleys D-30306



► Drawer Quantity and Dimensions: 4x100 + 1x205 mm



Tool Cars D-30.318

Width 1000mm Depth 500mm Height 500mm



► Drawer Quantity and Dimensions: 4x100 + 1x205 mm

Tool Cars D-30.316

Width 725 mm Depth 500 mm Height 1300mm



► Drawer Quantity and Dimensions: 4x100 + 1x205 mm

Tool Cars D-30.308

Width 600 mm Depth 500 mm Height 500mm



► Drawer Quantity and Dimensions: 1x100 mm

Tool Cars D-30.304

Width 595mm Depth 450 mm Height 900 mm



► Drawer Quantity and Dimensions: 1x100 mm

Tool Cars D-30.302

Width 1200 mm Depth 570 mm Height 400mm



► Drawer Quantity and Dimensions: 2x100 mm

Tool Cars D-30.314

Width 1200 mm Depth 570 mm Height 1400mm



► Drawer Quantity and Dimensions: 1x100 mm

Tool Trolleys D-30402



Tool Cars D-30,404

Width 1000mm Depth 500mm Height 870 mm



► Drawer Quantity and Dimensions: -

Tool Cars D-30,502

Width 1000mm Depth 570mm Height 2000mm



► Drawer Quantity and Dimensions: 4x100 + 1x205 mm

Tool Cars D-30,310

Width 900 mm Depth 490 mm Height 525mm



► Drawer Quantity and Dimensions: -

Tool Cars D-30,312

Width 900 mm Depth 490 mm Height 1525mm



► Drawer Quantity and Dimensions: -

Tool Cars D-30,604

Width 1230 mm Depth 620 mm Height 1050mm



► Drawer Quantity and Dimensions: 10x100 + 2x205 mm

10 Drawer Caisson G-80.102



► Drawer Quantity and Dimensions: 10x100 mm



9 Drawer Caisson G-50.104

Width 732 mm Depth 500 mm Height 1275 mm



► Drawer Quantity and Dimensions: 8x100 + 1x205 mm

8 Drawer Caisson G-50.106

Width 732 mm Depth 500 mm Height 1275 mm



► Drawer Quantity and Dimensions: 8x125 mm

7 Drawer Caisson G-50.108

Width 732 mm Depth 500 mm Height 1275 mm



► Drawer Quantity and Dimensions: 2x100 + 4x150 + 1x205 mm

7 Drawers Caisson G-50.110

Width 732 mm Depth 500 mm Height 1275 mm



► Drawer Quantity and Dimensions: 6x130 + 1x205 mm

7 Drawers Caisson G-50.112

Width 732 mm Depth 700 mm Height 980 mm



► Drawer Quantity and Dimensions: 7x100 mm

6 Drawer Caisson G-50.114

Width 732 mm Depth 700 mm Height 930 mm



► Drawer Quantity and Dimensions: 6x117 mm

5 Drawer Caisson G-50.116

Width 614 mm Depth 700 mm Height 930 mm



► Drawer Quantity and Dimensions: 4x100 + 1x205 mm

10 Drawer Caisson G-50.124

Width 732 mm Depth 700 mm Height 1690 mm



► Drawer Quantity and Dimensions: 5x100 + 2x150 + 3x205 mm

4 Drawer Caisson G-50.126

Width 900 mm Depth 450 mm Height 930 mm



► Drawer Quantity and Dimensions: 3x100 + 1x150 mm

Material Molaps





Cover System



The material cabinet has a double-door system with a 135° opening panel.

Hinge with Brake



The hinge that allows the doors to close automatically and slowly.

Perforated Panel



Since the inside of the cabinet and the doors are covered with perforated board, it can be used as a hanging board when desired.

Shelf System



There are 3 height adjustable material shelves in the material cabinet. Carrying capacity of a shelf is 80 kg.

Telescopic Rail System



Metry Telescopic rails with 100% opening and high product carrying capacity are used in all our drawers.

Latch Lock System



Thanks to the latch lock system in each drawer, it prevents unintentional opening of the drawers.

Adjustable Feet



Chrome-plated legs that can be adjusted independently of each other to prevent the work bench's posture balance from being affected by floor irregularities.

Electrostatic Powder Coating



All of our products are painted with electrostatic powder paint. Two different paint technologies, smooth and rough, are used.

Wide Color Choice



Freedom to choose the desired color with a wide range of standard colors and corporate color options.

Material Cabinet F40.102



► Drawer Quantity and Dimensions: 4x100 mm

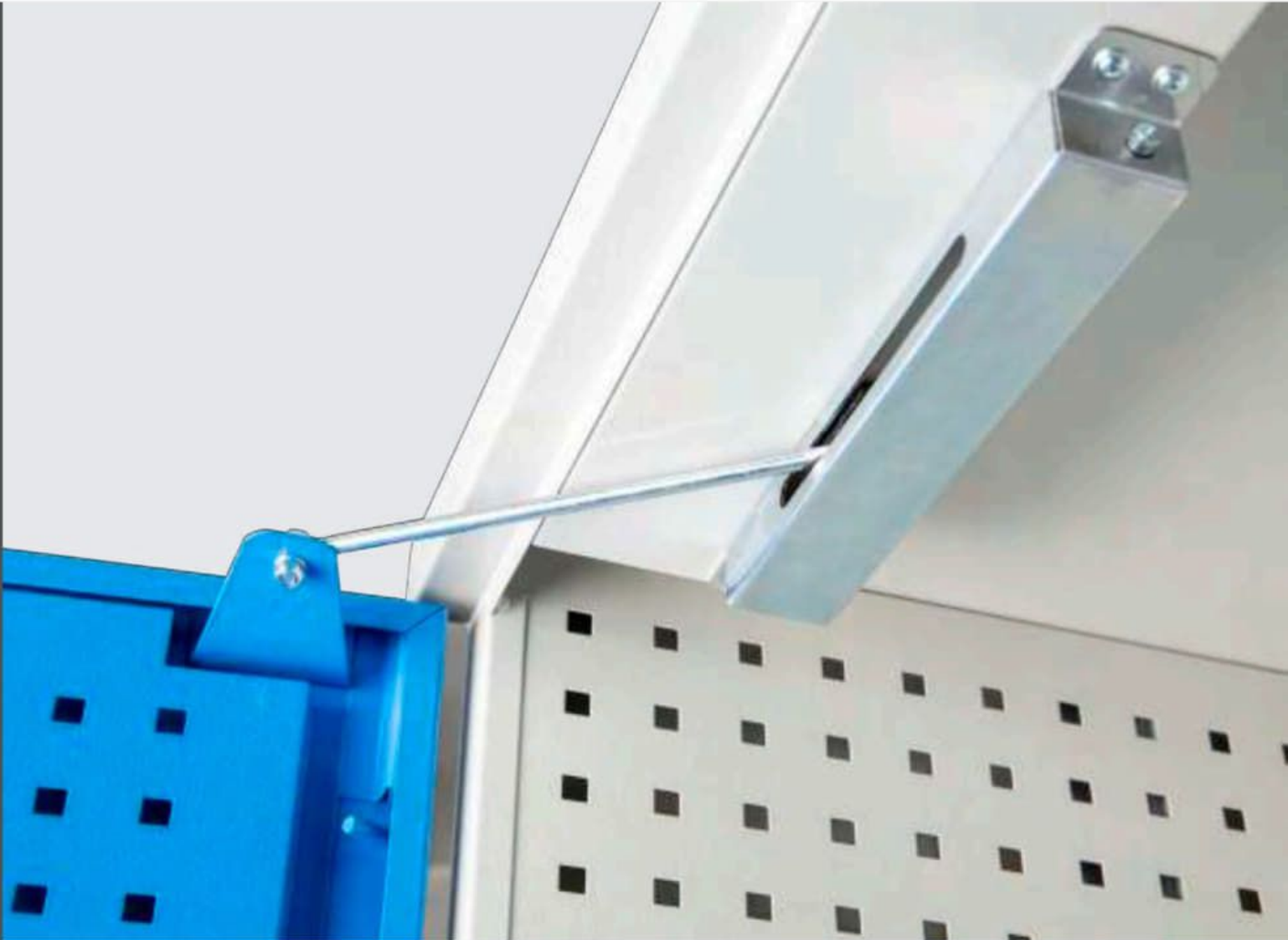

Material Cabinet F-40.106

Width 1000 mm Depth 550 mm Height 2000 mm



► Drawer Quantity and Dimensions: 3x100 + 1x205 mm

Material Cabinet F-40.104

Width 1200 mm Depth 550 mm Height 2000 mm



► Drawer Quantity and Dimensions: 6x205 mm

Material Cabinet F-40.108

Width 1200 mm Depth 550 mm Height 2000 mm



► Drawer Quantity and Dimensions: 6x100 + 2x205 mm

Material Cabinet F-40.110

Width 1000 mm Depth 600 mm Height 2000 mm



► Drawer Quantity and Dimensions: -

*Accessories on the products are not included in the prices.

Material Cabinet F40.154



Material Cabinet F-40.152

Width 1000 mm Depth 450 mm Height mm



► Drawer Quantity and Dimensions: 1x100 mm

Material Cabinet F-40.156

Width 1000 mm Depth 450 mm Height mm



► Drawer Quantity and Dimensions: -

Material Cabinet F-40,306

Width 1500 mm Depth 450 mm Height mm



► Drawer Quantity and Dimensions: -

Material Cabinet F-40,302

Width 1000 mm Depth 450 mm Height mm



► Drawer Quantity and Dimensions: -

*Accessories on the products are not included in the prices.

Material Cabinet F-40,170

Width 1000 mm Depth 450 mm Height 0 mm



► Drawer Quantity and Dimensions: -

Material Cabinet F-40,172

Width 1000 mm Depth 450 mm Height 0 mm



► Drawer Quantity and Dimensions: -

Material Cabinet F-40,174

Width 1000 mm Depth 450 mm Height 0 mm



► Drawer Quantity and Dimensions: -

Material Cabinet F-40,176

Width 1000 mm Depth 450 mm Height 0 mm



► Drawer Quantity and Dimensions: -

Material Cabinet F-40,252

Width 1000 mm Depth 450 mm Height 2000 mm



► Drawer Quantity and Dimensions: 1x100 mm

Material Cabinet F-40,254

Width 1000 mm Depth 500 mm Height 2000 mm



► Drawer Quantity and Dimensions: -

Material Cabinet F-40,182

Width 732 mm Depth 500 mm Height 1000 mm



► Drawer Quantity and Dimensions: 1x100 + 1x205 mm

Material Cabinet F-40,180

Width 732 mm Depth 500 mm Height 1000 mm



► Drawer Quantity and Dimensions: 1x100 + 1x205 mm

*Accessories on the products are not included in the prices.

Material Cabinet 41.102



► Drawer Quantity and Dimensions: 1x100 mm



Material Cabinet F-40.202

Width 1000 mm Depth 550 mm Height mm



► Drawer Quantity and Dimensions: 3x100 mm

Material Cabinet F-40.204

Width 1000 mm Depth 550 mm Height mm



► Drawer Quantity and Dimensions: 3x100 + 2x205 mm

Hanging File Cabinet F-48.102

Width 800 mm Depth 300 mm Height mm



► Drawer Quantity and Dimensions: 4x305 mm

Hanging File Cabinet F-48.104

Width 440 mm Depth 500 mm Height mm



► Drawer Quantity and Dimensions: 4x305 mm

*Accessories on the products are not included in the prices.



Chemical Material Cabinet F-2.104



Chemical Material Cabinet F-42.102

Width 1000 mm Depth 600 mm Height 2200 mm



► Drawer Quantity and Dimensions: -

Medicine Cabinet F-40.104

Width 1000 mm Depth 500 mm Height 2000 mm



► Drawer Quantity and Dimensions: 2x100 mm

Fire Resistant Material Cabinet F-45.104

Width 575 mm Depth 500 mm Height 1130 mm



► Drawer Quantity and Dimensions: -

Fire Resistant Material Cabinet F-45.102

Width 1180 mm Depth 640 mm Height 1960 mm



► Drawer Quantity and Dimensions: -

*Accessories on the products are not included in the prices.

Cabinet with Mors Holder E-35.102



- ▶ Drawer Quantity and Dimensions: 4x100 mm
- ▶ Walrus Holders: SH - 30,40,50 / HSK - 16,32,40,50,63,80



Cabinet with Mors Holder E-35.104

Width 720 mm Depth 700 mm Height 1500 mm



► Walrus Holders : BT - 30,40,50

Cabinet with Morse Holder E-35.106

Width 720 mm Depth 725 mm Height 1200 mm



► Drawer Quantity and Dimensions: 3x100 mm
 ► Walrus Holders: SH - 30,40,50 / HSK - 16,32,40,50,63,80

Cabinet with Morse Holder E-35.108

Width 900 mm Depth 600 mm Height 2000 mm



► Walrus Holders : BT - 30,40,50

Cabinet with Mors Holder E-35.112

Width 720 mm Depth 725 mm Height 1200 mm



► Drawer Quantity and Dimensions: 2x100 mm
 ► Walrus Holders: SH - 30,40,50 / HSK - 16,32,40,50,63,80

Morse Holder Car E-35.154



- ▶ Drawer Quantity and Dimensions: 4x100 + 1x205 mm
- ▶ Walrus Holders: SH - 30,40,50 / HSK - 16,32,40,50,63,80



Morse Holder Car E-35.140

Width 1000mm Depth 500mm Height 1330mm



- ▶ Drawer Quantity and Dimensions: 4x100 + 1x205 mm
- ▶ Walrus Holders : BT - 30,40,50

Walrus Holder Car E-35.158

Width 1000mm Depth 500mm Height 1330mm



- ▶ Drawer Quantity and Dimensions: 4x100 + 1x205 mm
- ▶ Walrus Holders: SH - 30,40,50 / HSK - 16,32,40,50,63,80

Morse Holder Car E-35.202

Width 1000mm Depth 500mm Height 900mm



- ▶ Drawer Quantity and Dimensions: 3x100 + 1x300 mm
- ▶ Walrus Holders : BT - 30,40,50

Morse Holder Car E-35.204

Width 1000mm Depth 500mm Height 900mm



- ▶ Drawer Quantity and Dimensions: 3x100 + 1x300 mm
- ▶ Walrus Holders : BT - 30,40,50

Morse Holder Car E-35.152

Width 675mm Depth 450mm Height 900mm



- ▶ Drawer Quantity and Dimensions: 4x80 + 1x300 mm
- ▶ Walrus Holders : BT - 30,40,50

Morse Holder Car E-35.144

Width 615mm Depth 450mm Height 1330mm



- ▶ Drawer Quantity and Dimensions: 4 x 100 + 1 x 205 mm
- ▶ Walrus Holders : BT - 30,40,50

*Accessories on the products are not included in the prices.

Morse Holder Car E-35.156



- ▶ Drawer Quantity and Dimensions: 4x100 + 1x300 mm
- ▶ Walrus Holders: SH - 30,40,50 / HSK - 16,32,40,50,63,80



Morse Holder Car E-35.146

Width 1000mm Depth 500mm Height 1050mm



► Walrus Holders: SH - 30,40,50 / HSK - 16,32,40,50,63,80

Morse Holder Car E-35.150

Width 1300 mm Depth 500 mm Height 900mm



► Walrus Holders : BT - 30,40,50

Rack with Morse Holder E-35.130

Width 900 mm Depth 340 mm Height 1690mm

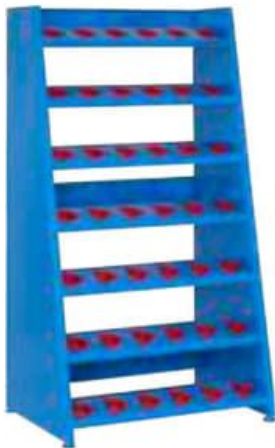

► Walrus Holders: SK - 30,40,50

Morse Holder Table E-35.160

Width 1000mm Depth 500mm Height 430mm



► Walrus Holders : BT - 30,40,50

Morse Holder Car E-35.162

Width 600 mm Depth 500 mm Height 430mm



Walrus Holders : BT - 30,40,50

Operator Cabinet 85.102



► Drawer Quantity and Dimensions: 1x100 mm



Computer Cabinet O-85.128

Width 1050 mm Depth 700mm Height 1720mm



► Drawer Quantity and Dimensions: 1x115 mm

Computer Cabinet O-85.130

Width 1050 mm Depth 700mm Height 1720mm



► Drawer Quantity and Dimensions: 1x115 mm

Computer Cabinet O-85.124

Width 600 mm Depth 700mm Height 1720mm



► Drawer Quantity and Dimensions: 1x115 mm

Computer Cabinet O-85.126

Width 600 mm Depth 700mm Height 1720mm



► Drawer Quantity and Dimensions: 1x115 mm

Operator Stand O-85.116

Width 615 mm Depth 450 mm Height 1100 mm



► Drawer Quantity and Dimensions: 1x100 mm

Operator Stand O-85.118

Width 1000 mm Depth 450 mm Height 1100 mm



► Drawer Quantity and Dimensions: 1x100 mm

Locker H-55.106

Width 1180 mm Depth 400 mm Height 2000 mm



Locker H-55.104

Width 1200 mm Depth 400 mm Height 350 mm



Locker H-55.108

Width 800 mm Depth 400 mm Height 2000 mm



Locker H-55.110

Width 1180 mm Depth 400 mm Height 350 mm



Locker H-55.112

Width 800 mm Depth 400 mm Height 1850 mm



Locker H-55.114

Width 500 mm Depth 400 mm Height 1850 mm



Locker H-55.102

Width 1000 mm Depth 450 mm Height 2000 mm



Locker H-55.116

Width 870 mm Depth 400 mm Height 1800 mm



Tool Cabinet P.90.150



- Drawer Quantity and Dimensions: 3x100 mm
- Tools: 30 Pieces of 100 Toolboxes, 21 Pieces of 200 Toolboxes, 12 Items of 300 Toolboxes,



Tool Cabinet P-90.158

Width 1000 mm Depth 450 mm Height 2000 mm



► Toolboxes: 40 Pieces of Toolboxes of 300

Tool Stand P-90.122

Width 1240 mm Depth 450 mm Height 700mm



► Tools: 80 pieces of tool, 100 pieces of tool, 48 pieces of 150 tools, 24 pieces of 200 tools, 10 pieces of 250 tools,

Tool Stand P-90.124

Width 1000mm Depth 390mm Height 1020mm



► Tools: 36 Pieces of 100 Tool, 14 Pieces of 150 Tool, 12 Pieces of 200 Tool, 10 Pieces of 250 Tool,

Tool Stand P-90.126

Width 970 mm Depth 670 mm Height 1530 mm



► Utensils: 48 Utensils of 100, 28 of 150, 24 of 200, 10 of 250, 24 of 300,

Tool Stand P-90.128

Width 1240 mm Depth 300 mm Height 540 mm



► Tools: 40 Pieces of 100 Tool, 16 Pieces of 150 Tool, 12 Pieces of 200 Tool, 5 Pieces of 250 Tool,

Tool Stand P-90.130

Width 850 mm Depth 850 mm Height 1950 mm



► Tools: 200 pieces, 120 pieces

Box Cabinet with Drawers P-90.162

Width 1140 mm Depth 440 mm Height 1830 mm



- Plastic Drawer Boxes:
- Set 401-9 Plastic Drawer 81 Pieces,
 - Set 401-6 Plastic Drawer 72 Pieces,
 - Set 401-3 Plastic Drawer 18 pcs,
 - Set 401-4 Plastic Drawer 24 pcs,
 - Set MS-2 Plastic Drawer 80 pcs,



Box Stand P-90.352

Width 915 mm Depth 300 mm Height 2000 mm



► Boxes with Plastic Drawers: Set 175 Plastic Drawers 80 pcs.

Box Stand P-90.350

Width 915 mm Depth 300 mm Height 2000 mm



► Boxes with Plastic Drawers: Set 120 Plastic Drawers 154 Pieces.

Carousel P-90.120

Width 580 mm Depth 580 mm Height 1430 mm

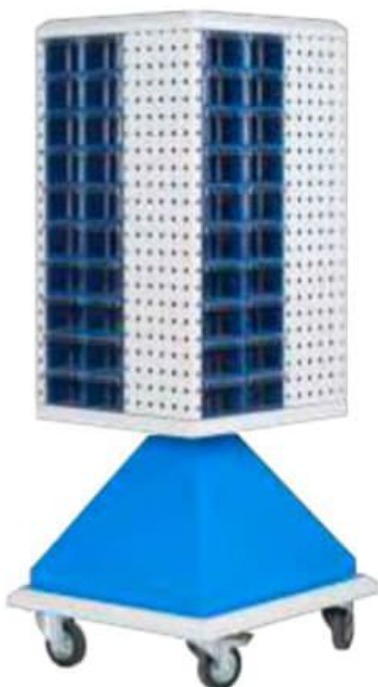

► Boxes with Plastic Drawers: Set 120 Plastic Drawers 80 pcs.

Carousel P-90.118

Width 700 mm Depth 700 mm Height 1750 mm



► Boxes with Plastic Drawers: Set 120 Plastic Drawers 180 pcs.

Package Trolley **K-60.102**

Width 700 mm Depth 1120 mm Height 920 mm



Package Trolley **K-60.104**

Width 800 mm Depth 1120 mm Height 920 mm



Package Trolley **K-60.106**

Width 800 mm Depth 1120 mm Height 920 mm



Package Trolley **K-60.108**

Width 800 mm Depth 1200 mm Height 920 mm



Package Trolley **K-60.110**

Width 700 mm Depth 1000 mm Height 920 mm



Package Trolley **K-60.112**

Width 800 mm Depth 1200 mm Height 920 mm



Package Trolley **K-60.114**

Width 455 mm Depth 745 mm Height 900 mm



Package Trolley **K-60.116**

Width 600 mm Depth 450 mm Height 1170 mm



Package Trolley **K-60.117**

Width 500 mm Depth 450 mm Height 1170 mm



Package Trolley **K-60.118**

Width 400 mm Depth 450 mm Height 1170 mm



Package Trolley **K-60.162**

Width 1060 mm Depth 790 mm Height 920 mm



Package Trolley **K-60.160**

Width 1000 mm Depth 790 mm Height 920 mm



Tube Transport Trolley **K-60.120**

Width 530 mm Height 1000mm



Tube Transport Trolley **K-60.122**

Width 830 mm Height 1000mm



Tube Transport Trolley **K-60.128**

Width 530 mm Depth 450 mm Height 1380 mm



Tube Transport Trolley **K-60.130**

Width 510 mm Depth 550 mm Height 1380 mm



Tube Connection **K-60.132**

Width 795 mm Depth 260 mm Height 1200 mm



Tube Connection **K-60.134**

Width 530 mm Depth 260 mm Height 1200 mm



Barrel Transport Trolley **K-60.140**

Width 560 mm Depth 950 mm Height 540 mm



Barrel Transport Trolley **K-60.146**

Width 700 mm Height 550mm



Motor Transport Trolley **K-60.152**

Width 800 mm Depth 1000 mm Height 600 mm



Engine Stand **K-60.150**

Width 700 mm Depth 1100 mm Height 1000 mm



Heavy Shelving Unit L-65.102

Width 2000 mm Depth 500 mm Height 2000 mm



Light Shelving Unit L-65.104

Width 1500 mm Depth 500 mm Height 2000 mm



Light Shelving Unit L-65.106

Width 1015 mm Depth 500 mm Height 2000 mm



Light Shelving Unit L-65.108

Width 1000 mm Depth 400 mm Height 2000 mm



Shelf Unit with Drawers L-65.110

Width 700 mm Depth 600 mm Height 2200 mm



Cantilever Arm Stock Rack L-65.118

Width 4500 mm Depth 1100 mm Height 2000 mm



Material Rack L-65.204

Width 1240 mm Depth 540 mm Height 1540 mm



Display Stand L-65.214

Width 1220 mm Depth 920 mm Height 1480 mm



Display Stand L-65.208

Width 1200 mm Depth 550 mm Height mm



Fittings Stock Rack L-65.144

Width 1000 mm Depth 550 mm Height mm



Fittings Stock Rack L-65.146

Width 1000 mm Depth 500 mm Height mm



Fittings Stock Rack L-65.148

Width 1000 mm Depth 550 mm Height mm



Barrel Stand L-65.112

Width 1200 mm Depth 950 mm Height 1200 mm



Barrel Stand L-65.114

Width 1800 mm Depth 800 mm Height 1900 mm



Barrel Stand L-65.115

Width 1800 mm Depth 800 mm Height 900 mm



Tire Stacking Rack L-65.116

Width 2050 mm Depth 600 mm Height 2000 mm



Study desk M-75.302

Width 1500 mm Depth 720 mm Height 800 mm



Study desk M-75.304

Width 1400 mm Depth 750 mm Height 750 mm



Chip Container M-75.160

Width 964 mm Depth 1120 mm Height 1000 mm



Chip Container M-75.162

Width 1800 mm Depth 1035 mm Height 1000 mm



Ladder M-75.134

Width 800 mm Depth 1500 mm Height 2000 mm



Team Hanging Board M-75.178

Width 2760 mm Depth 1510 mm Height 2000 mm



Protection Cabine M-75,216



Protection Cabine M-75,218



Protection Cabine M-75,214



Protection Cabine M-75,204



Protection Cabine M-75,206



Protection Cabine M-75,208



Equipment Cabine N-80.102

Width 1700 mm Depth 550 mm Height 2000mm



Equipment Cabine N-80.104

Width 1000 mm Depth 550 mm Height 1600mm



Equipment Cabine N-80.118

Width 1000 mm Depth 500 mm Height 2000mm



Equipment Cabine N-80.120

Width 1000 mm Depth 500 mm Height 1100mm



Equipment Rack N-80.112

Width 1240 mm Depth 500 mm Height 2000mm



Equipment Rack N-80.132

Width 2000 mm Depth 500 mm Height 2000mm



Locker N-80.126

Width 1000 mm Depth 700 mm Height 2110mm



Locker N-80.128

Width 1000 mm Depth 700 mm Height 2110mm



Locker N-80.130

Width 1000 mm Depth 700 mm Height 1110mm



Equipment Cabinet N-80.124

Width 1000 mm Depth 500 mm Height 2000mm



Equipment Rack N-80.122

Width 900mm Depth 400mm Height 1870mm



Equipment Rack N-80.106

Width 900 mm Depth 400 mm Height 1870 mm



Vehicle Equipment FrT-61402



Vehicle Equipment FrT-61403



Vehicle Hardware FrT-61530



Vehicle Interior Equipment FrT-6140



Vehicle Hardware RM-61406



Vehicle Hardware MaT-61302



Vehicle Hardware **FrT-61534**



Vehicle Hardware **FrT-61528**



Vehicle Hardware FD-61516



In -Vehicle Equipment FrT-61522



Vehicle Hardware **FrT-61436**



Vehicle Interior Equipment **RM-61440**



Vehicle Hardware **MrS-61038**



Vehicle Interior **FrC-61270**



Vehicle Hardware **FrC-71096**



Vehicle Equipment **RT-71126**



Vehicle Hardware RT-71100



Vehicle Equipment RT-71102



Vehicle Hardware RT-71104



Vehicle Hardware RT-71086



Vehicle Hardware NS-81120



Vehicle Equipment FiD-81122



Vehicle Hardware **FrC-81114**



Vehicle Equipment **FD-81154**



Screwdriver Hanger - 030



Flat Key Hanger - 031



Flat-Star Key Hanger - 032



Allen Hanger - 034



Set of 2 - 036



Clip Hook - 037



Cable Winding Apparatus - 038



Brochure Holder - 039



Triple Sprayer - 040



1 Sprayer - 041



Double Long Narrow Hook - 042



Double Short Wide Hook - 043



Double Long Wide Hook - 044



Square Long Hook - 045



Square Short Hook - 046



Diameter 70 mm Hook - 047



Diameter 50 mm Hook - 048



Diameter 35 mm Hook - 049



Single 150 mm Hook - 050



Single 85 mm Hook - 051

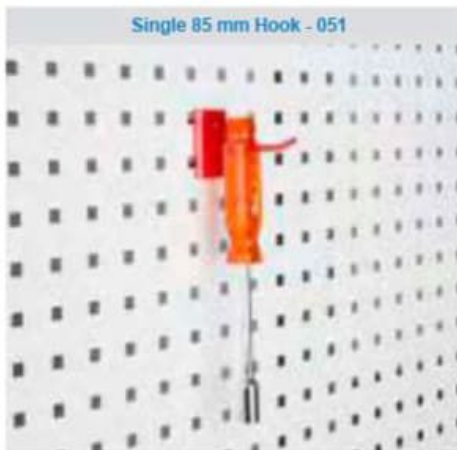

Single 55 mm Hook - 052



Single 35 mm Hook - 053





www.metray.com



INDUSTRIAL TYPE TELESCOPIC RAIL

Metray telescopic rails; The product groups with 27 mm, 35 mm and 45 mm widths are also available in standard sizes with different lengths from 250 mm to 1000 mm. Our rails, which have passed through various test stages, have successfully passed all tests without falling apart. Metray telescopic rails have a heavy load carrying capacity from 35 kg to 160 kg depending on the models. Drawers and platforms also have a 100% opening system that provides ease of use. The products are also nickel plated. All of our products are manufactured and assembled in-house. Emphasizing R&D activities, METRAY always aims to reach the best.

COMPACT TYPE INDUSTRIAL TELESCOPIC RAIL SERIES

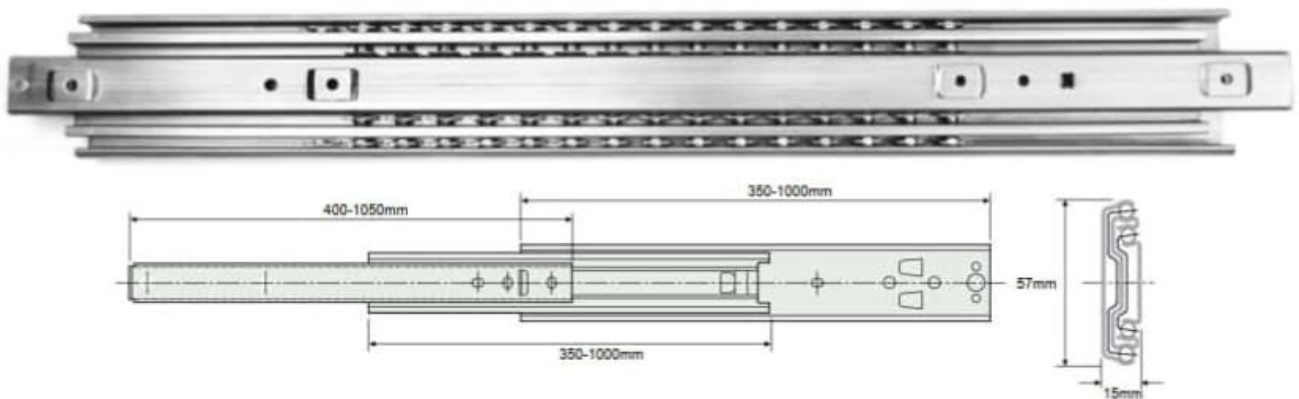

Product code	K-57,350	K-57,400	K-57,450	K-57,500	K-57,550	K-57,600	K-57,650	K-57,700	K-57,750
Outer Body	2mm	2mm	2mm	2mm	2mm	2mm	2mm	2mm	2mm
Inner Body	1.5mm	1.5mm	1.5mm	1.5mm	1.5mm	1.5mm	1.5mm	1.5mm	1.5mm
Covering	anodized	anodized	anodized	anodized	anodized	anodized	anodized	anodized	anodized
Length	350mm	400mm	450mm	500mm	550mm	600mm	650mm	700mm	750mm
Transport Cap.	125 kg.	120 kg.	115 kg.	110 kg.	105 kg.	100 kg.	95 kg.	90 kg.	85 kg.

Product code	K-57,800	K-57,850	K-57,900	K-57,950	K-57,1000
Outer Body	2mm	2mm	2mm	2mm	2mm
Inner Body	1.5mm	1.5mm	1.5mm	1.5mm	1.5mm
Covering	anodized	anodized	anodized	anodized	anodized
Length	800mm	850mm	900mm	950mm	1000mm
Transport Cap.	80 kg.	75 kg.	70 kg.	65 kg.	60 kg.

LIGHT TYPE INDUSTRIAL TELESCOPIC TRACK SERIES

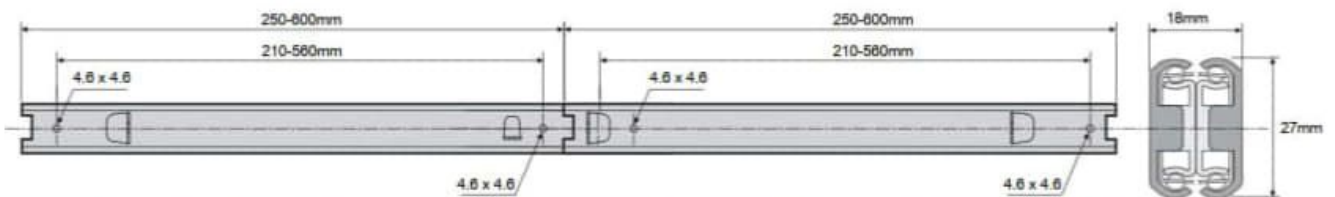

Product Code	A-27.250	A-27.300	A-27.350	A-27.400	A-27.450	A-27.500	A-27.550	A-27.600
Outer	1.5mm	1.5mm	1.5mm	1.5mm	1.5mm	1.5mm	1.5mm	1.5mm
Body	1.5mm	1.5mm	1.5mm	1.5mm	1.5mm	1.5mm	1.5mm	1.5mm
Inner	Nickel	Nickel	Nickel	Nickel	Nickel	Nickel	Nickel	Nickel
Body	250mm	300mm	350mm	400mm	450mm	500mm	550mm	600mm
Coating Length	Carrying Cap. 70 kg	65 kg.	60 kg.	55 kg.	50 kg.	45 kg.	40 kg.	35 kg.

MEDIUM TYPE INDUSTRIAL TELESCOPIC RAIL SERIES

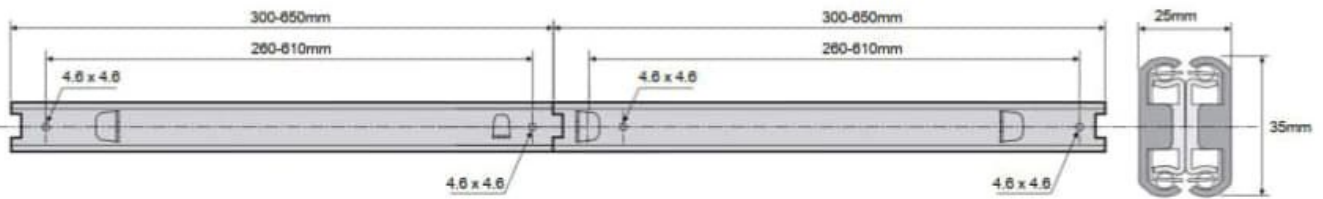

Product Code	B-35,300	B-35,350	B-35,400	B-35,450	B-35,500	B-35,550	B-35,600	B-35,650
Outer Body Inner Body	2mm	2mm	2mm	2mm	2mm	2mm	2mm	2mm
Coating Length	2mm	2mm	2mm	2mm	2mm	2mm	2mm	2mm
	Nickel	Nickel	Nickel	Nickel	Nickel	Nickel	Nickel	Nickel
	300mm	350mm	400mm	450mm	500mm	550mm	600mm	650mm
Transport Cap.	105 kg.	100 kg.	95 kg.	90 kg.	85 kg.	80 kg.	75 kg.	70 kg.

MEDIUM TYPE INDUSTRIAL TELESCOPIC RAIL SERIES

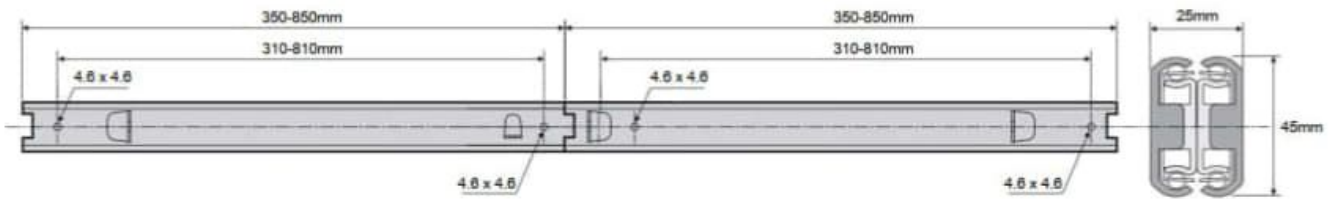

Product Code	B-45,300	B-45,350	B-45,400	B-45,450	B-45,500	B-45,550	B-45,600	B-45,650	B-45,700
Outer Body Inner Body	2mm	2mm	2mm	2mm	2mm	2mm	2mm	2mm	2mm
Coating Length	2mm	2mm	2mm	2mm	2mm	2mm	2mm	2mm	2mm
	Nickel	Nickel	Nickel	Nickel	Nickel	Nickel	Nickel	Nickel	Nickel
	300mm	350mm	400mm	450mm	500mm	550mm	600mm	650mm	700mm
Transport Cap.	135 kg.	130 kg.	125 kg.	120 kg.	115 kg.	110 kg.	105 kg.	100 kg.	95 kg.

Product Code	B-45,750	B-45,800	B-45,850
Outer Body	2mm	2mm	2mm
Inner Body	2mm	2mm	2mm
Covering	Nickel	Nickel	Nickel
Length	300mm	350mm	400mm
Transport Cap.	90 kg.	85 kg.	80 kg.

HEAVY DUTY INDUSTRIAL TELESCOPIC RAIL SERIES

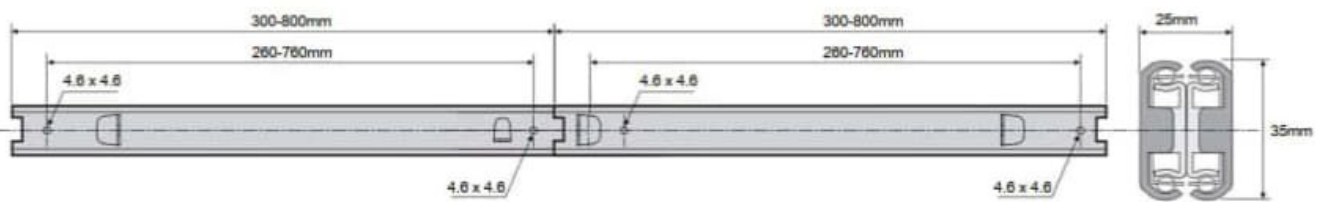
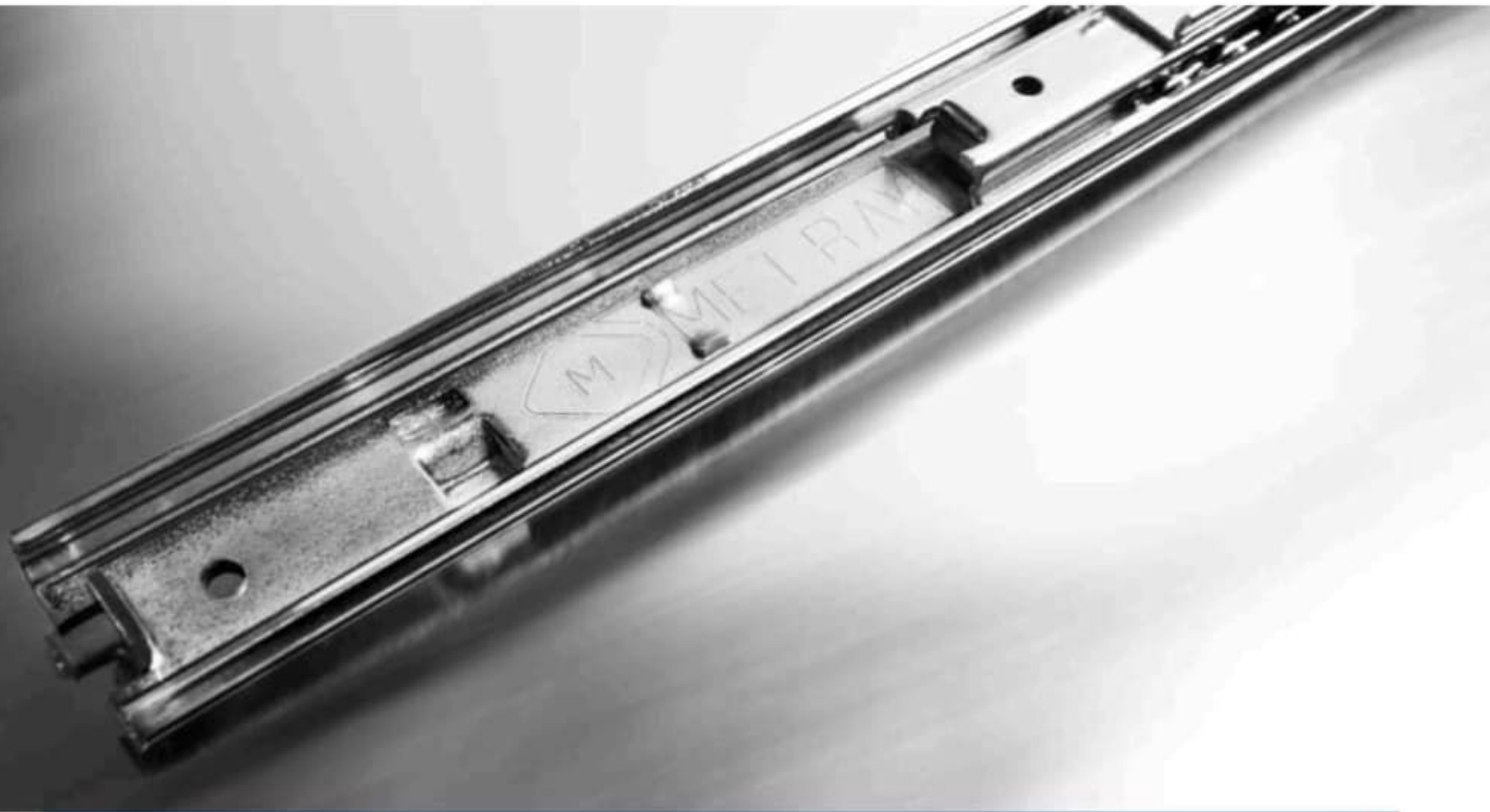

Product code	C-35,300	C-35,350	C-35,400	C-35,450	C-35,500	C-35,550	C-35,600	C-35,650	C-35,700
Outer Body	2.5mm	2.5mm	2.5mm	2.5mm	2.5mm	2.5mm	2.5mm	2.5mm	2.5mm
Inner Body	2mm	2mm	2mm	2mm	2mm	2mm	2mm	2mm	2mm
Covering	Nickel	Nickel	Nickel	Nickel	Nickel	Nickel	Nickel	Nickel	Nickel
Length	300mm	350mm	400mm	450mm	500mm	550mm	600mm	650mm	700mm
Transport Cap.	130 kg.	125 kg.	120 kg.	115 kg.	110 kg.	105 kg.	100 kg.	95 kg.	90 kg.

Product code	C-35,750	C-35,800
Outer Body	2.5mm	2.5mm
Inner Body	2mm	2mm
Covering	Nickel	Nickel
Length	300mm	350mm
Transport Cap.	85 kg.	80 kg.

HEAVY DUTY INDUSTRIAL TELESCOPIC RAIL SERIES

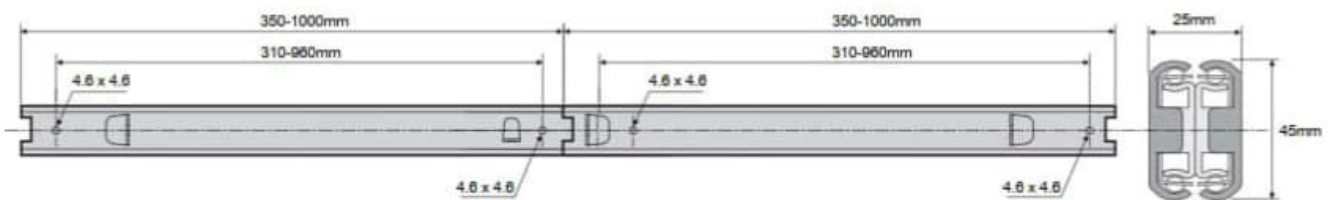

Product code	C-45350	C-45,400	C-45,450	C-45,500	C-45550	C-45600	C-45650	C-45700	C-45,750
Outer Body	2.5mm	2.5mm	2.5mm	2.5mm	2.5mm	2.5mm	2.5mm	2.5mm	2.5mm
Inner Body	2mm	2mm	2mm	2mm	2mm	2mm	2mm	2mm	2mm
Covering	Nickel	Nickel	Nickel	Nickel	Nickel	Nickel	Nickel	Nickel	Nickel
Length	300mm	350mm	400mm	450mm	500mm	550mm	600mm	650mm	700mm
Transport Cap.	160 kg.	155 kg.	150 kg.	145 kg.	140 kg.	135 kg.	130 kg.	125 kg.	120 kg.

Product code	C-45,800	C-45850	C-45,900	C-45,950	C-45.1000
Outer Body	2.5mm	2.5mm	2.5mm	2.5mm	2.5mm
Inner Body	2mm	2mm	2mm	2mm	2mm
Covering	Nickel	Nickel	Nickel	Nickel	Nickel
Length	300mm	350mm	400mm	400mm	400mm
Transport Cap.	115 kg.	105 kg.	95 kg.	85 kg.	75 kg.

HEAVY DUTY INDUSTRIAL TELESCOPIC RAIL SERIES

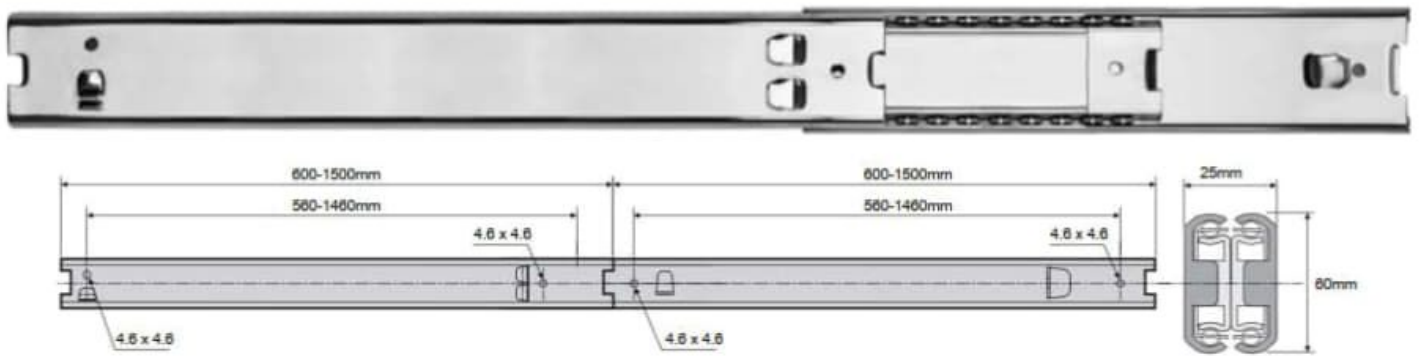

Product code	C-60600	C-60700	C-60,800	C-60.900	C-60.1000	C-60.1100	C-60.1200	C-60.1300	C-60.1400
Outer Body	2.5mm	2.5mm	2.5mm	2.5mm	2.5mm	2.5mm	2.5mm	2.5mm	2.5mm
Inner Body	2.5mm	2.5mm	2.5mm	2.5mm	2.5mm	2.5mm	2.5mm	2.5mm	2.5mm
Covering	Nickel	Nickel	Nickel	Nickel	Nickel	Nickel	Nickel	Nickel	Nickel
Length	600mm	700mm	800mm	900mm	1000mm	1100mm	1200mm	1300mm	1400mm
Transport Cap.	180 kg.	170 kg.	160 kg.	150 kg.	140 kg.	130 kg.	120 kg.	110 kg.	100 kg.

Product code	C-45.1500
Outer Body	2.5mm
Inner Body	2.5mm
Covering	Nickel
Length	1500mm
Transport Cap.	90 kg.

HEAVY DUTY INDUSTRIAL TELESCOPIC RAIL SERIES

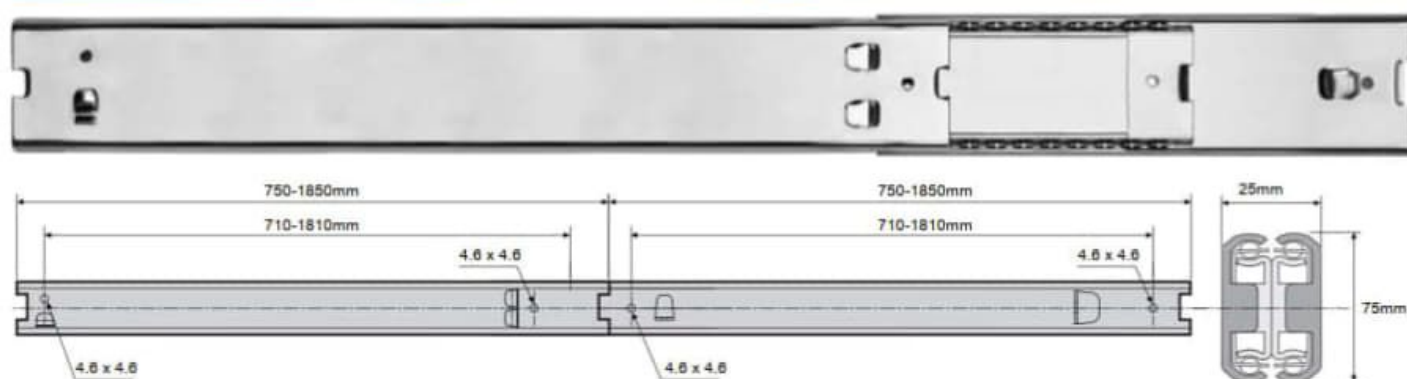

Product code	C-75,750	C-75,850	C-75,950	C-75,1050	C-75,1150	C-75,1250	C-75,1350	C-75,1450	C-75,1550
Outer Body	2.5mm	2.5mm	2.5mm	2.5mm	2.5mm	2.5mm	2.5mm	2.5mm	2.5mm
Inner Body	2.5mm	2.5mm	2.5mm	2.5mm	2.5mm	2.5mm	2.5mm	2.5mm	2.5mm
Covering	Nickel	Nickel	Nickel	Nickel	Nickel	Nickel	Nickel	Nickel	Nickel
Length	750mm	850mm	950mm	1050mm	1150mm	1250mm	1350mm	1450mm	1550mm
Transport Cap.	220 kg.	210 kg.	200 kg.	190 kg.	180 kg.	170 kg.	160 kg.	150 kg.	140 kg.

Product code	C-75,1650	C-75,1750	C-75,1850
Outer Body	2.5mm	2.5mm	2.5mm
Inner Body	2.5mm	2.5mm	2.5mm
Covering	Nickel	Nickel	Nickel
Length	1650mm	1750mm	1850mm
Transport Cap.	130 kg.	120 kg.	110 kg.

TEXTILE SECTOR





MARITIME INDUSTRY





AUTOMOTIVE INDUSTRY



PUBLIC TRANSPORTATION MAINTENANCE GARAGES



MAINTENANCE AND REPAIR WORKSHOPS



THE INDUSTRY SECTOR



ENERGY SECTOR



CHEMICAL INDUSTRY



EDUCATION SECTOR



FOOD INDUSTRY



LABORATORIES







Factory

Address : Merve Mah. Necip Fazıl Cad. No:2
Sancaktepe / İSTANBUL
Phone : +90 216 311 50 88
Fax : +90 216 561 20 33
E-mail: info@akinmetal.com



Istanbul Store

Address : Osmangazi Mah. Koruluk Sok. No:30
Sancaktepe / İSTANBUL
Phone : 444 25 46
GSM : +90 549 289 29 00
E-mail: info@akinmetal.com



Ankara Store

Address : Ostim OSB Mahallesi Alinteri Bulvarı No:170
Ostim / Yeni Mahalle / ANKARA
Phone : +90 312 318 02 00
E-mail: ankaramagaza@akinmetal.com



www.metinakinmetal.com.tr